



# Pallet conveyor systems

Equipment designed to streamline the flow of goods and enhance productivity







## Improve your supply chain's competitive edge by controlling pallet flows

Pallet conveyors are designed to transport, accumulate a/o distribute goods to specific locations during the logistics operations of a warehouse, a production centre or between the two. They achieve maximum process efficiency for inputs, outputs and in-house handling of unit loads.

From the moment raw materials enter a production centre to when a final product is ready for the customer, goods need to be moved various times. In most cases, these are repetitive movements, with similar routes and are carried out manually or with standard, operator-run handling equipment. These warehouse fulfilment processes entail major overhead costs and additional resource use for companies, which drives up the final product's price.

Implementing a pallet conveyor system means workflows can be optimised, enhancing productivity and cutting down on manual load handling.

Even though the implementation of conveyors is generally associated with highly automated installations, in reality, conveyor systems are becoming more and more common in standard warehouses.

In particular, this is thanks to new generation plug & play technology that needs no programming, making it easy to set up simple conveyor circuits.

Our wide range of heavy-duty conveying equipment, and our extensive experience in implementing these types of solutions allows us to offer personalised advice on choosing a solution that works for you, based on each warehouse's logistics and operational data.



## INDEX

### Highlighted advantages

#### Types of conveyor circuits

- Plug & play circuits
- Simple circuits with a control module
- Average complexity circuits
- High complexity circuits
- Safety first

#### Basic conveyors

- Roller conveyors
- Chain conveyors
- Mixed transfer with rollers and chains
- Turntable conveyor with rollers or chains

#### Other conveying equipment

- Turntable conveyor with mixed transfer
- Conveyors with mechanical accumulation
- Conveyors with sequential accumulation
- Roller conveyors with entry/exit guide rails
- Hydraulic scissor tables with rollers
- Hydraulic lift tables
- Pallet transfer cars
- Pallet lifts
- Pallet transfer carts
- Full pallet stackers
- Pallet stacker/unstackers
- Hinged connectors for chain conveyors
- Electric monorails

#### Stainless steel equipment

#### Safety measures

- Pallet checkpoints
- Safety enclosures
- Conveyor fenders
- Horizontal safety mesh
- Pedestrian walkways
- Roller doors

#### Manage and control your system

- Galileo control software
- Easy WMS warehouse management system

#### Applications

#### After-sales services



# Highlighted advantages

Pallet conveyor systems multiply warehouse productivity and cut costs

1

## Increased productivity

By implementing pallet conveyor systems, operational activity increases in all types of warehouses.

- **Streamlining movements** and their efficiency.
- **Reducing** loading, unloading and transport runtimes between distant points of an installation.
- **Producing a constant flow of product** thanks to the accumulative system and the 24-hour operational capacity.
- **Preventing bottlenecks.** Powerful simulation tools test virtual workflows. By doing so, an optimal system can be planned.

2

## Cost savings

Maximum product standardisation by Mecalux facilitates its manufacture, assembly and commissioning, –decreasing its cost.

- **Saving workforce costs.** Operators involved in warehouse fulfilment processes can be reassigned to other tasks.
- **Quick ROI** by eliminating repetitive movements carried out in a warehouse and enhancing productivity.
- **Save in cold-storage power costs,** since a facility's pallet conveyors can connect the production exit to the cold-storage chamber –preventing temperature changes.
- Affordable, **low maintenance.**

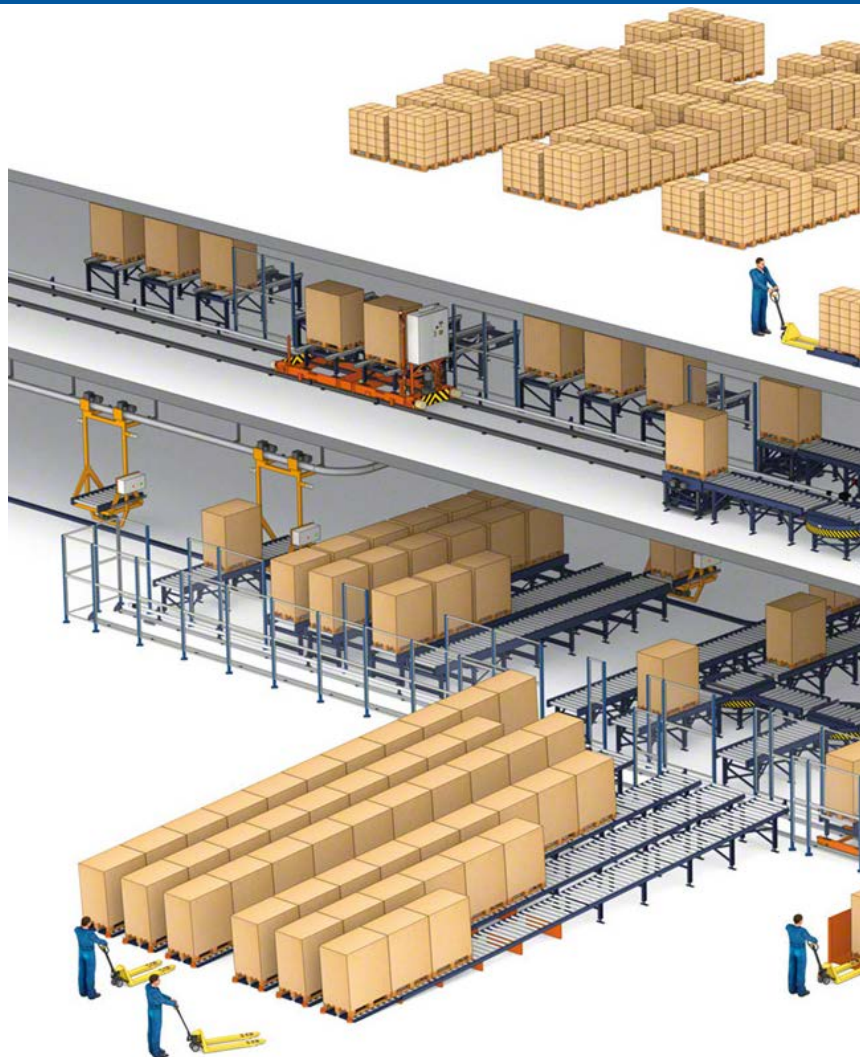

3

## Safety

Minimise the risk of accidents by reducing manual load handling, as well as forklift circulation.

Pallet conveyors include diverse components designed to protect the goods:

- **Mechanical pieces,** like channellers or stops, which guide the unit loads.
- **Electronic and monitoring components,** such as photocell sensors or frequency converters, ensure the smooth handling of unit loads.

**Partitions and wire safety mesh protect** areas at risk for trapping, crushing, falling materials, etc., fulfilling current regulations.



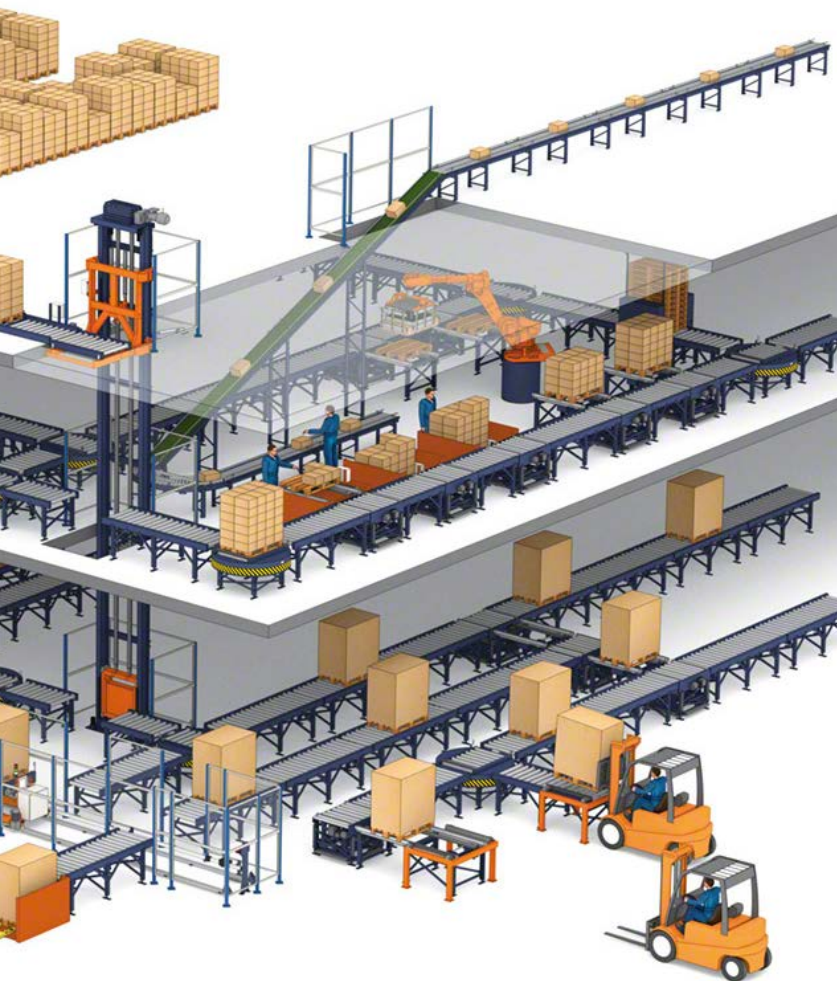

## 4

### Versatility

Create an unlimited number of circuits with our broad range of conveyor components.

- In addition to different configurable circuits, **pallets can accumulate, be lifted and turned, and the system connect work areas** and floors with varying operations, etc.
- In the **simplest installations**, users can put together their own circuit using the plug & play system, where up to 40 units can be connected easily.
- Units are **compatible with standard handling equipment**, like forklifts and pallet trucks, and with pre-existing conveyors.
- **Transporting non-standard or low-quality pallets is possible** by utilising slave pallets or custom solutions.
- Unit **standardisation means greater flexibility** in modifying circuits or in relocating them, adapting to your growing business.

## 5

### Manage and control

Our conveyor systems are scalable, allowing different degrees of automation.

- **In the case of average or highly complex circuits**, with several origin and destination points, conveyors work under the direction of a control system. Either a PLC or a PC is set up with our Galileo control software, which functions as the brain of the installation.
- **In the most complex systems**, such as automated warehouses, conveyors usually have an integrated warehouse management software. For example, our Easy WMS, which runs and manages pallet flows through a customised project design.



# Types of conveyor circuits

From the simplest to the most complex conveying solutions



An unlimited number of circuits can be put together to suit the most diverse pallet flows, no matter the length, or if they must even out levels, join various floors or connect passageways, either through raised or underground tunnels.

Most pallet logistics processes can be fulfilled with simple or non-complex circuits. For example:

- Connecting production sites.
- Moving pallets between production areas and the warehouses.
- Linking in-warehouse zones.
- Joining several production or warehouse floors.

- Having accumulation channels set up for unloading lorries.
- Carrying out preload tasks.
- Enabling a buffer zone between two production areas.

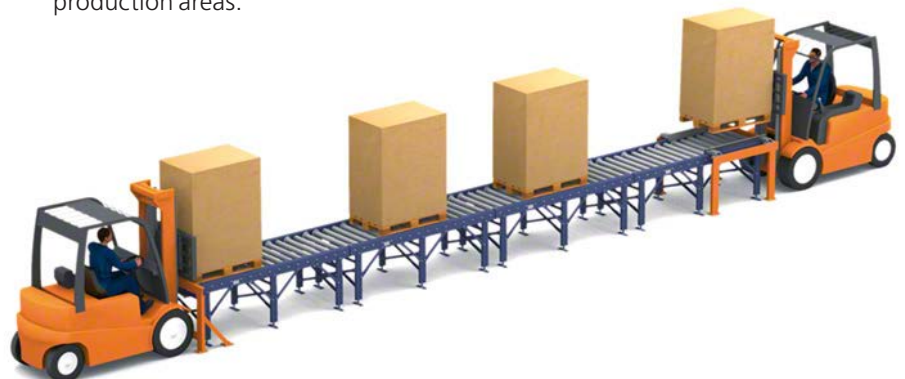





Depending on the conveyor modules used, circuits are classified as:

1. Plug & play circuits
2. Simple circuits with a control module
3. Average complexity circuits
4. High complexity circuits







## 1 Plug & play circuits

A straight circuit is the simplest to set up. It comprises a single conveyor type of suitable length that covers the entire required distance a/o the number of pallets wanted in circulation at once. Choosing longer or shorter conveyor modules will essentially depend on their use and the required accumulation capacity.

Besides the conveyor modules, which come with either rollers or chains depending on the direction pallets will move, a power box and a motion cuing device must also be installed.

This type of circuit does not require any programming, since it just 'plugs and plays'. Assembly is easy, letting each user configure their own circuit. Conveyor modules fit together in an interconnected line; each module recognises and interacts with the one in front and behind.

The start signal is given via a simple push button –which is pressed once the pallet is in place and the forklift has backed out– or a front facing photocell sensor does the same job.

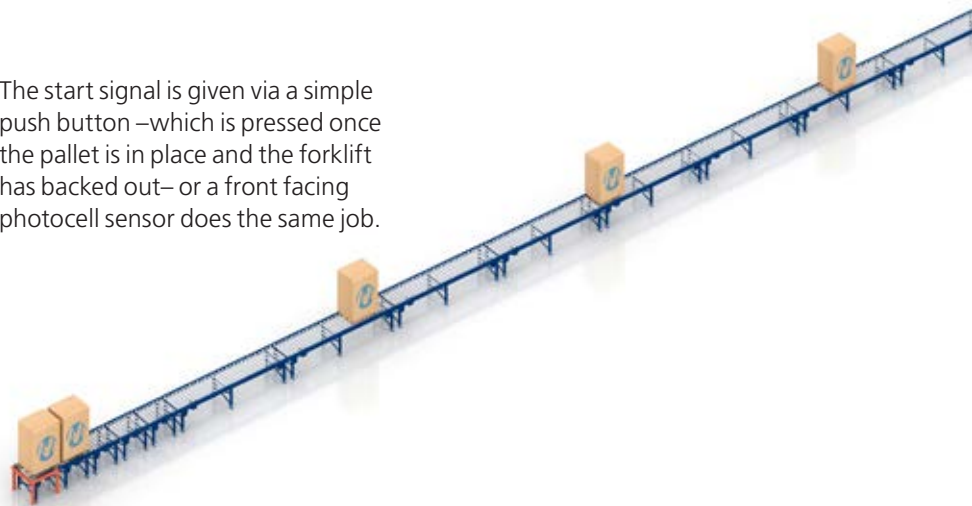

Likewise, an induction loop can be set up on the floor that activates once the forklift deposits a pallet and moves away.

A built-in beacon shows if the conveyor circuit is running.

There is also a simple switch for reversing the entire circuit, which

means pallets can be moved in both directions. If workflows are consistently bi-directional, it is better to set up two parallel circuits with the same features.





Any non-complex circuit can be enabled with these five conveyor types:



Roller conveyors



Chain conveyors



Mixed transfer with rollers and chains



Turntable conveyor with rollers



Turntable conveyor with chains







Any irregular shaped circuit can be arranged using these basic conveyor models, by combining sections of roller modules and others with chains, or by setting up a single module type.



**Combined roller and chain conveyor circuits**

Made of alternately placed roller and chain conveyor modules. A mixed transfer conveyor with rollers and chains needs to be installed (or a turntable with mixed transfer) where the two sections meet to change the direction of the pallets.

Directional changes happen along the entire conveyor route, whenever there is a perpendicular union point.

**Circuits with one conveyor type**

Always made of a single kind of conveyor module, this sort of circuit has either rollers or chains. So, pallets move along the circuit in the same direction.

In these cases, a turntable conveyor is used to link two sections and change the load's direction. Thus, it is possible to turn pallets at any angle, better adapting to even the most irregular circuits.

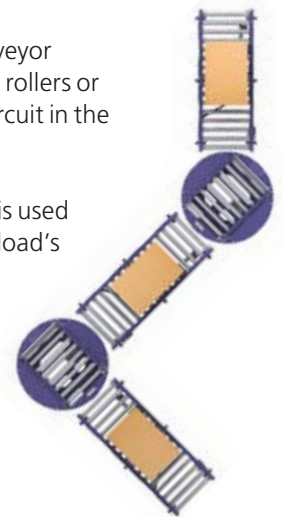





Plug & play circuits must fulfil one of the following criteria:

- Contain a single origin and a single destination.
- Contain a single origin and destination, which is also reversible.
- Contain various points of origin and a single destination.

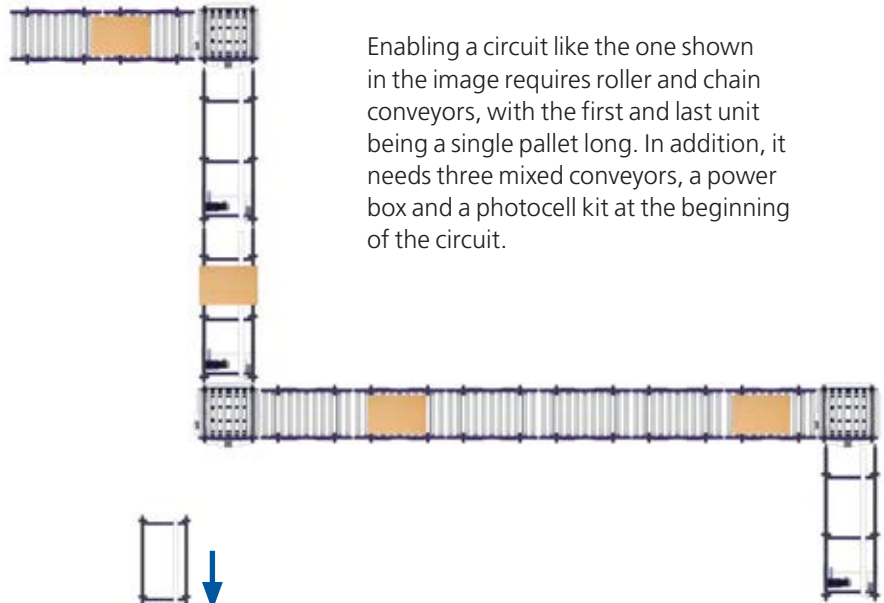

Enabling a circuit like the one shown in the image requires roller and chain conveyors, with the first and last unit being a single pallet long. In addition, it needs three mixed conveyors, a power box and a photocell kit at the beginning of the circuit.

This example shows various points of origin and a single destination.

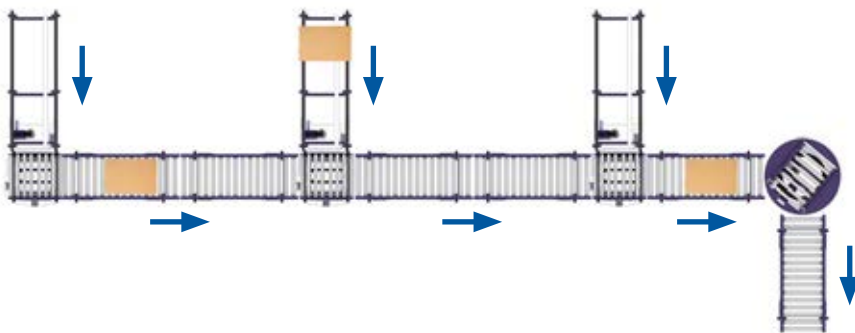

### Plug & play circuits with add-on equipment

This circuit type has broader applications by including equipment with its own independent control module. Basic conveyors only send or receive occupancy or stop signals.



Include one or more of the following pieces of equipment:



**Roller conveyors with entry/exit guide rails to load with pallet trucks.** These units are indispensable when handling goods at ground level with pallet trucks. They are available with and without lift devices.

**Single-depth transfer cars.** These can act as the main conveyor in a circuit with several origin points and a single destination, joining various locations. They are a good option when workflows are not elevated, and long distances need to be covered affordably.

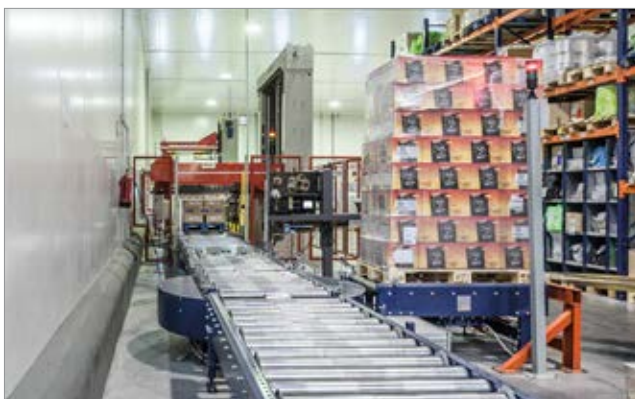

**External devices.** Stretch wrappers, balers, scales, automatic doors, etc. can be installed that include their own control module. They interact with the conveyors in a very straightforward manner.



**Roller conveyors with mechanical accumulation.** They can provide continuous transport or accumulate up to sixteen 1,200 mm long pallets in each conveyor section. They are an excellent choice for setting up straight circuits or for the continuous accumulation of pallets.



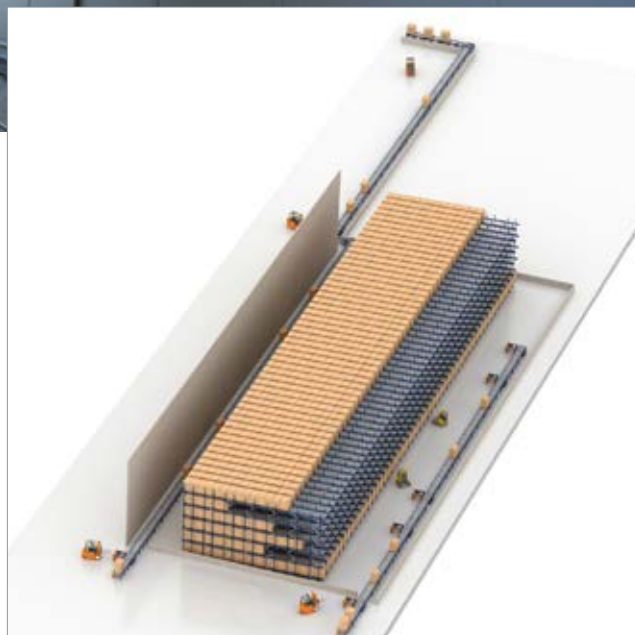
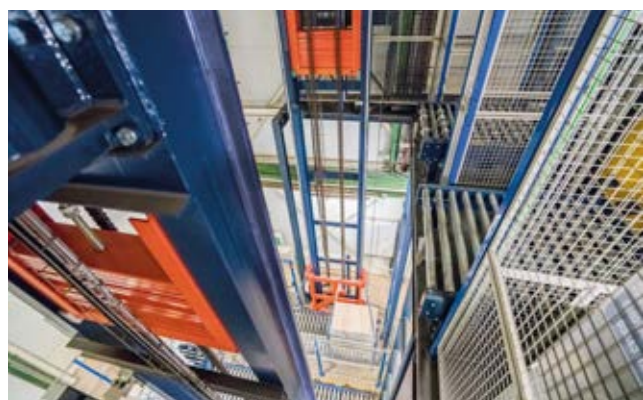
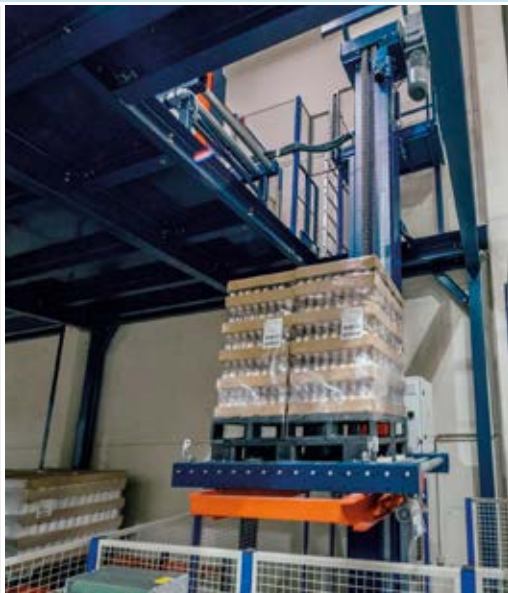

**Pallet lifts.** Lifts connect sizeable distances between levels, link floors or even join two buildings separated by a street, by constructing a covered overpass or a tunnel.

**Manual selector switches for destinations and reversibility.** Circuits can be reversible with only one origin point and one destination equipped with lift conveyors or pallet lifts, as well as basic plug & play conveyors. This feature is not available with mechanical accumulation conveyors or when they include external devices.



Include this option on circuits with one origin point and various destinations, even if the primary element is a single transfer car, by installing a manual selector switch for choosing destination channels.

**Lift table for conveyors.** Use these tables to even out small differences on the floor, by changing the transport height.

The illustration above shows a block of live racks with conveyors in both aisles. The left-hand one, for outgoing goods, has several origin points and a single destination, thus, requiring no control module. The one for outputs requires a manual selector that indicates which destination a pallet must be sent to, since the circuit has a single entry point and several pick-up stations where an operator awaits to insert the pallet in the racks.

## 2 Simple circuits with a control module

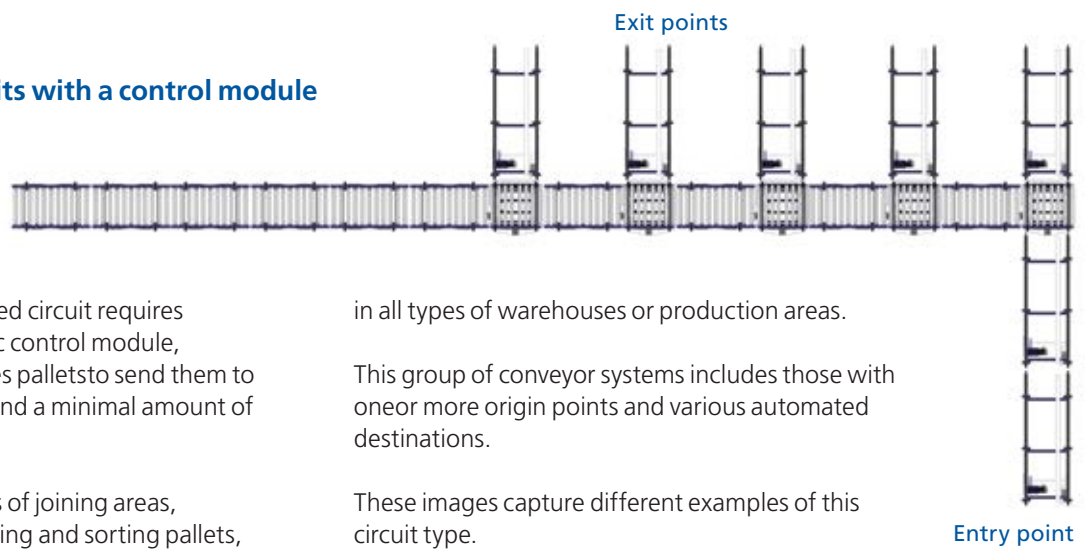

This type of medium-sized circuit requires the installation of a basic control module, equipment that identifies pallets to send them to a specified destination and a minimal amount of programming.

They can solve problems of joining areas, transporting, accumulating and sorting pallets,

in all types of warehouses or production areas.

This group of conveyor systems includes those with one or more origin points and various automated destinations.

These images capture different examples of this circuit type.



Products flowing from manufacturing or assembly lines are **accumulated and sorted on chain conveyors**.



Pallets coming from manufacturing or goods reception are **moved to one of three destination stations** located at one end of the warehouse.





Pallets flowing from the warehouse or picking zones are **sorted into preload channels using a transfer car.**



In this example, pallets from production move toward outgoing channels, with **the transfer car in charge of linking the different origin channels** to the destination ones.

Besides all the equipment in the previous group, these conveyor circuits include **straight accumulation conveyors** (with rollers or chains), which hold up to four pallets. Each pallet's position is managed through photocell sensors. For this reason, several control modules are required and simple programming that runs according to specific rules.





### 3 Average complexity circuits

A specific control software, like our Galileo programme, and suitable hardware are necessary, since the origin and destination points are diverse and interact differently.

Moreover, average complexity circuits mainly comprise conveyor modules and other basic equipment, but link several different areas. Here are some examples.

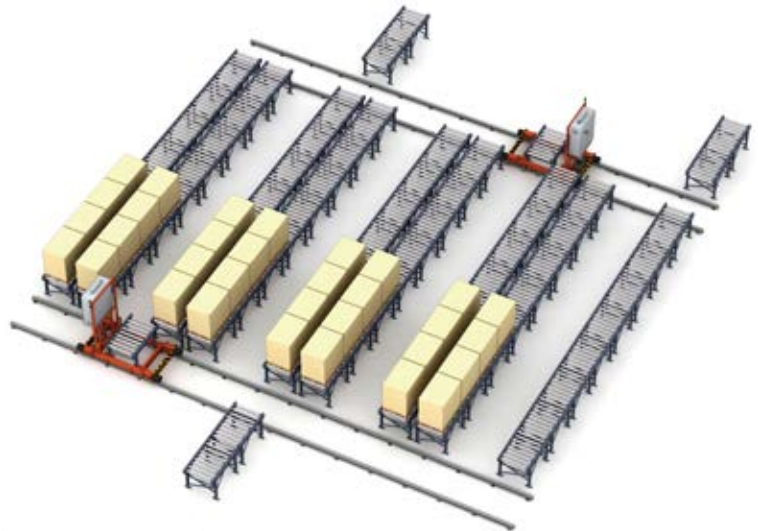

A circuit that acts as **an interim buffer between two production areas**, with sequential accumulation conveyors. These conveyors work in conjunction with two single-loading transfer cars (one on each side), which link the different channels.



Here, it shows a **circuit that joins different parts of a warehouse**, including water treatment zones. Transfer cars are also used as sorting and reception equipment.



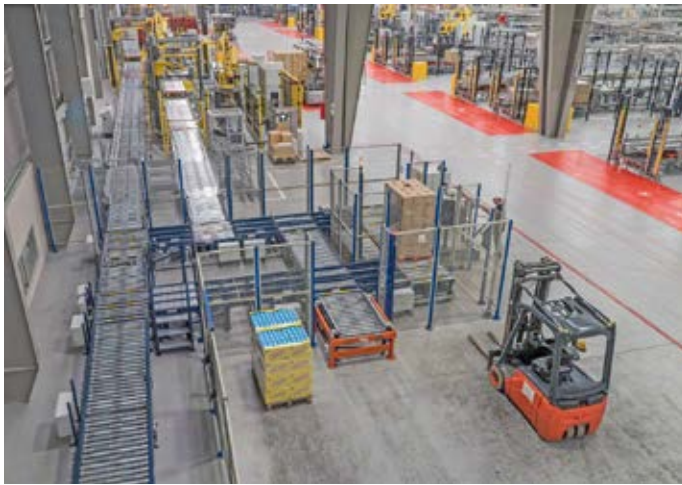

In this case, the **conveyors connect different production zones** and these zones, in turn, connect to the warehouse. They include direct links to palletising equipment output points, inputs by forklifts, and the verification and quality control zone.

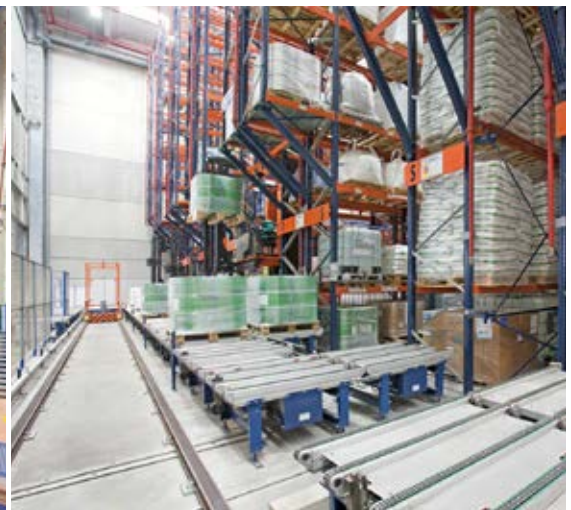

In this example, it shows the input and outputs **docks connected to the main conveyor system of the warehouse aisles**. Here, trilateral turret trucks carry out movements between these positions and the rack locations. Linking the different warehouse aisles can take place through conveyors or transfer cars. The transfer car (bottom image) is in charge of linking the aisle conveyors to the input and output ones in the receipt and dispatch zone. It has non-complex programming.



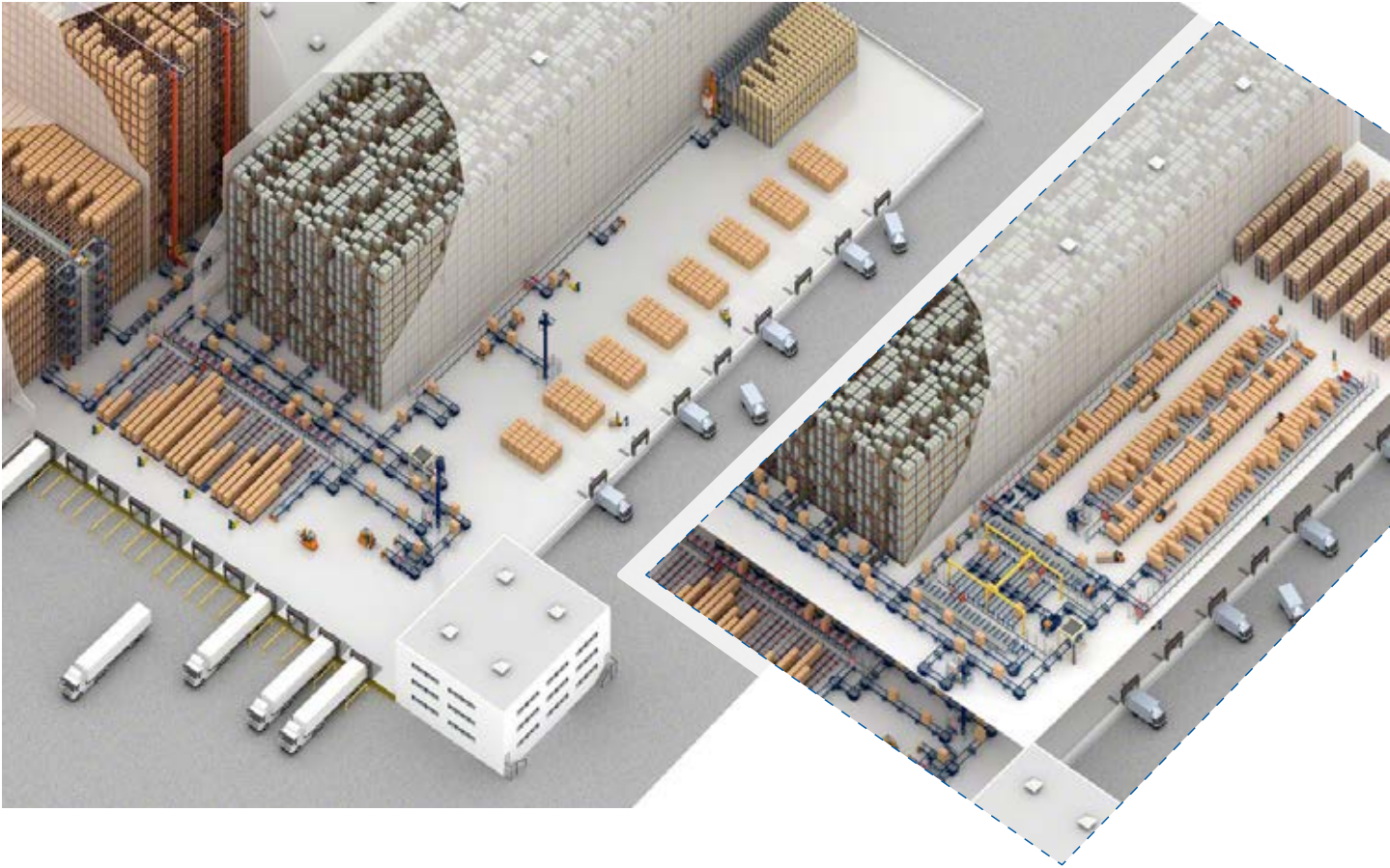

## 4 High complexity circuits

These circuits encompass an infinite number of solutions, combining basic equipment with more specialised ones, either in production or warehousing zones, or where these connect.

Often these installations are part of a solution that includes, in most cases, automated warehouses with very

high workflows and a multitude of origin and destination points.

For this reason, highly complex circuits usually include a warehouse management software, like our Easy WMS, which automates and optimises all circuit movements and communicates with the ERP of a business. Easy WMS is designed for

scaled implementation, depending on how complex the logistics operations of an installation may be, and is 100% customisable.

The illustration on this page shows how complex an installation can be when arranged with roller and chain conveyors.

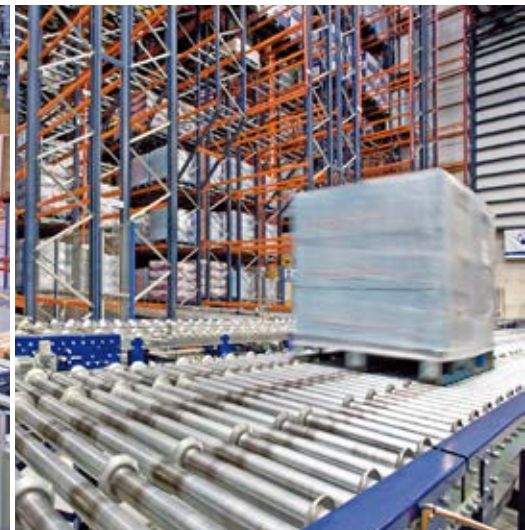









### Safety first

Once a circuit is installed, whatever its complexity, it functions automatically, meaning certain moving parts must be protected, according to local regulations.

When this happens, a risk assessment must be done, like in any other production area, and the most appropriate protective systems installed (see the "Safety features" section).

Regardless of what is established in the regulations, it is crucial to protect lifts, transfer cars and other elements correctly to prevent people from entering their operating radius.





Circuits are supplemented by safety enclosures, such as mesh panelling and restricted access doors, which provide maximum protection for workers in a facility.





# Basic conveyors

Use rollers or chains to move pallets as efficiently as possible





## Roller conveyors



These cost-effective conveyors provide lengthwise flows and cover long distances at a low cost, transporting loads between different locations in an installation. Pallets are transferred with their skids facing the direction they move in and perpendicularly supported on the rollers.

Conveyors are available for different pallet widths (800, 1,000, 1,200 mm and half pallets).



### TECHNICAL DATA

**Required unit:** Euro pallet, as per UNE-EN 13698:2003

**Max. load size:** 900 / 1,100 / 1,300 x 1,300 mm

**Standard lengths:** 1,340 / 2,676 / 3,010 mm

**Distance between rollers:** 167 mm

**Roller diameter:** 80 mm

**Pallet guides:** guide wheels

**Brake:** optional

**Mechanical end-stop:** optional

**Standard transport height:** 600 / 900 / 1,100 mm

**Max. unit load weight:** 1,500 kg

**Speed:** 10-20 m/min

**Temperature range:** -30°C to +40°C  
and a max. 70% humidity



## Chain conveyors



Equipment for transporting pallets where skids face perpendicular to the direction the pallets flow (Euro pallets handled by the 1,200 mm side). A single width lets all pallet types be transported. Half pallets require a particular conveyor module with four chain strands.

If the unit load's base, namely the pallet, is of good quality and a standard Euro pallet size, the most common approach would be to install conveyors with two chain strands. Otherwise, conveyors with three or four strands will provide more support points.



### TECHNICAL DATA

**Required unit:** Euro pallet, as per UNE-EN 13698:2003

**Max. load size:** 900 / 1,100 / 1,300 x 1,300 mm

**Standard lengths:** 1,302 / 2,006 / 2,710 mm

**Unit lengths:** available lengths + 70 mm

**Pallet guides:** optional channellers

**Mechanical end-stop:** optional

**Standard transport height:** 650 / 950 / 1,150 mm

**Max. unit load weight:** 1,500 kg

**Speed:** 10-20 m/min

**Chain conveyor strands:**  
2, 3 or 4 as per configuration

**Temperature range:** -30°C to +40°C  
and a max. 70% humidity



## Mixed transfer with rollers and chains



A combined roller and chain conveyor that allows changes in pallet direction flows and orientation. The rollers are fixed to a bedplate, and the chains are placed on a lifting frame. The chain conveyor's height is always 50 mm higher than the rollers, to make sure it operates properly.

Combining both components in a single module is the best way to incorporate changes in flows and in the conveyor system, either from chains to rollers or vice versa.

Configurations are available in variable conveyor lengths adapted to 800, 1,000 and 1,200 mm wide pallets. Conveyor modules also come specifically for moving half pallets.



### TECHNICAL DATA

**Required unit:** Euro pallet, as per UNE-EN 13698:2003

**Max. load size:** 900 / 1,100 / 1,300 x 1,300 mm

**Max. unit load weight:** 1,500 kg

**Standard chain transport height:** 650 / 950 / 1,150 mm

**Standard roller transport height:**  
600 / 900 / 1,100 mm

**Roller diameter:** 80 mm

**Fall prevention stop for rollers:** optional

**Fall prevention stop for chains:** optional

**Hinged stop for rollers:** optional

**Speed:** 10-20 m/min

**Lift cycle:** 3 s

**Chain conveyor strands:** 2, 3 or 4 as per configuration

**Entry photocells:** 2

**Temperature range:** -30°C to +40°C  
and a max. 70% humidity



## Turntable conveyor with rollers or chains



A turntable with rollers or chains lets the pallet's direction be changed, while keeping the load facing the same way between separate but similar type conveyor strands (rollers or chains).

It can send the pallet towards an entry point at any angle. Moving 800, 1,000 and 1,200 mm wide pallets is possible. There is also a conveyor module specifically for half pallets, which comes with rollers or chains.



### TECHNICAL DATA

**Required unit:** Euro pallet, as per UNE-EN 13698:2003

**Max. load size:** 900 / 1,100 / 1,300 x 1,300 mm

**Max. unit load weight:** 1,500 kg

**Standard chain transport height:** 650 / 950 / 1,150 mm

**Standard roller transport height:** 600 / 900 / 1,100 mm

**External diameter:** 1,730 / 1,830 / 1,975 mm

**Roller diameter:** 80 mm

**Speed:** variable up to 20 m/min

**Chain conveyor strands:** 3 or 4 as per configuration

**Turning speed:** 90° in 4 s

**Position sensors:** 2

**Flashing entry photocells:** 2

**Reflective photocells:** 1 / 2

**Temperature range:** -30°C to +40°C  
and a max. 70% humidity







## Other conveying equipment

Accumulation, transport and lift systems, as well as auxiliary equipment for fluid, unlimited movements





## Turntable conveyor with mixed transfer



The turntable with rollers or chains makes it possible to change the pallet's direction, as well as the way the load faces with the option of changing from chains to rollers, or vice versa, in a straight line.

Configurations are available in variable conveyor lengths adapted to 800, 1,000 and 1,200 mm wide pallets. Conveyor modules also come specifically for moving half pallets.

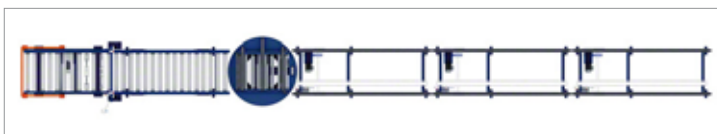

### TECHNICAL DATA

**Required unit:** Euro pallet, as per UNE-EN 13698:2003

**Max. load size:** 900 / 1,000 / 1,300 x 1,300 mm

**Max. unit load weight:** 1,500 kg

**Standard chain transport height:** 650 / 950 / 1,150 mm

**Standard roller transport height:** 600 / 900 / 1,100 mm

**Roller diameter:** 80 mm

**Speed:** variable up to 20 m/min

**Chain conveyor strands:** 3 or 4 as per configuration

**Flashing entry photocells:** 2

**Reflective photocells:** 1 / 2

**Temperature range:** -30°C to +40°C  
and a max. 70% humidity



## Conveyors with mechanical accumulation



A roller system with brakes to let several pallets accumulate, reducing material and maintenance costs. Loads are moved as single units, with the system being capable of transporting from 4 to 16 loads on the same conveyor line driven by one motor or four parallel lines of up to four unit loads each.

Circuits are created by linking different conveyor sections, but the beginning and end need a single roller conveyor module, a lift or other independently moving elements.



### TECHNICAL DATA

**Required unit:** Euro pallet, as per UNE-EN 13698:2003

**Max. load size:** 900 x 1,300 mm

**Available lengths:** No. of pallets x 1,352 mm

**Roller diameter:** 80 mm

**Distance between rollers:** 167 mm

**Pallet guides:** guide wheels

**Standard transport height:** 600 mm

**Max. unit load weight:** 1,000 kg

**Speed:** 7 m/min

**Temperature range:** -30°C to +40°C  
and a max. 70% humidity

**Flashing photocell set:** as per configuration



## Conveyors with sequential accumulation



These straight conveyors (with rollers or chains) provide lengthwise flows and cover long distances at a low cost, transporting loads between different points in an installation. Transport is sequential, since it is designed to move up to 4 pallets/module at once. Each pallet's position is managed by means of photocells that let pallets accumulate, while keeping them spaced slightly apart.

Speed is limited to 8 m/min. However, a buffer area can be created, and a greater number of pallets can accumulate in the circuit. Combine with single load conveyors at the entry and exit points. They operate via a particular sequence and an electronic control system.



### TECHNICAL DATA

**Required unit:** Euro pallet, as per UNE-EN 13698:2003

**Max. load size:** 900 / 1,100 / 1,300 x 1,300 mm

**Available lengths:**

Roller conveyor: 2,839 mm (2 loads)

4,175 mm (3 loads)/5,511 mm (4 loads)

Chain conveyor: from 2,108 to 5,736 mm

**Pallet guides:** guide wheels

**Standard transport height:**

600 / 900 / 1,100 mm (rollers)

650 / 950 / 1,150 mm (chains)

**Max. unit load weight:** 4 x 1,500 kg

**Speed:** 8 m/min

**Chain conveyor strands:**

3 or 4 as per configuration

**Temperature range:** -30°C to +40°C

and a max. 70% humidity

**Flashing photocell set:** 1



## Roller conveyors with entry/exit guide rails



Use this conveyor to insert or extract unit loads from a circuit via a pallet truck at ground level, without the need for forklifts. As there is no lifting system, a hydraulic table must be connected or the rest of the conveyor should be set lower.

Choose between conveyors adapted to 800, 1,000 or 1,200 mm wide pallets, as well as half pallets (consult other pallet or base sizes).

### TECHNICAL DATA

Available length: 1,520 mm

Roller diameter: 60 mm

Pallet guides: exterior or lateral collars

Transport height: 80 mm

Max. unit load weight: 1,500 kg

Speed: 10-20 m/min

Temperature range: -30°C to +40°C  
and a max. 70 % humidity

Flashing photocell set:

1 (speed 10 m/min) / 2 (speed 20 m/min)









## Ground level conveyor



It carries out ground level, lengthwise movements between various points of an installation when the floor's clearance height is inadequate or a pit cannot be dug due to constructive restrictions.

Attach it to a raising element like a hydraulic table or a lift to link it to a different transport height.

Conveyors are available for different pallet widths (800, 1,000, 1,200 mm and half pallets).



### TECHNICAL DATA

**Required unit:** Euro pallet, as per UNE-EN 13698:2003

**Max. load size:** 900 / 1,100 / 1,300 x 1,300 mm

**Available lengths:**  
1,336 mm (min.) up to 5,344 mm (max.)

**Roller diameter:** 80 mm

**Pallet guides:** lateral collars

**Brake:** optional

**Mechanical end-stop:** optional

**Standard transport height:** 80 / 100 mm

**Max. unit load weight:** 1,500 kg

**Speed:** 10 - 20 m/min

**Temperature range:** -30°C to +40°C  
and a max. 70% humidity



## Hydraulic tables



This kind of table is recommended to ensure an ergonomic position for the operator working at a picking station. It adjusts the height of the goods to a correct handling position during order picking tasks.

Hydraulic tables also used to level out small sections in a conveyor circuit. Lifting ranges from 100 mm to 2,000 mm.

Chain or roller conveyors can be assembled on top of these tables, based on the requested application and function.

### TECHNICAL DATA

Pallet width: 800 / 1,000 / 1,200 mm

Max. unit load weight: 1,500 kg

Available length: 1,500 mm





## Hydraulic scissor table with rollers



This equipment lifts the unit load from the ground level to the circuit's height, through a hydraulic lift system. Two versions of this conveyor are available:

### Hydraulic tables with full rollers

Use these to level out height differences between conveyors.

### Hydraulic tables with split rollers

Install these when the load needs raising from the ground to the conveyor's height. They can also operate with pallet trucks.

### TECHNICAL DATA

Pallet width: 800 / 1,000 / 1,200 mm

Max. unit load weight: 1,500 kg

Available length: 1,675 mm

Lower level transport height: 80 mm

Roller diameter: 60 mm

Speed: 10-20 m/min

Pallet guide: via channellers

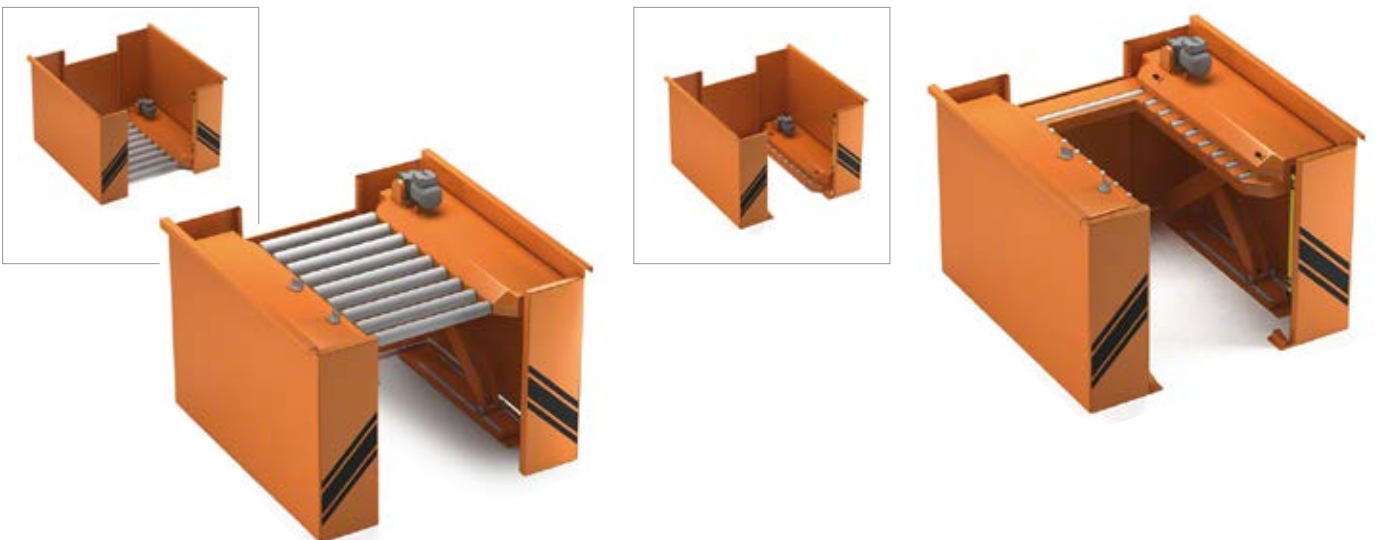



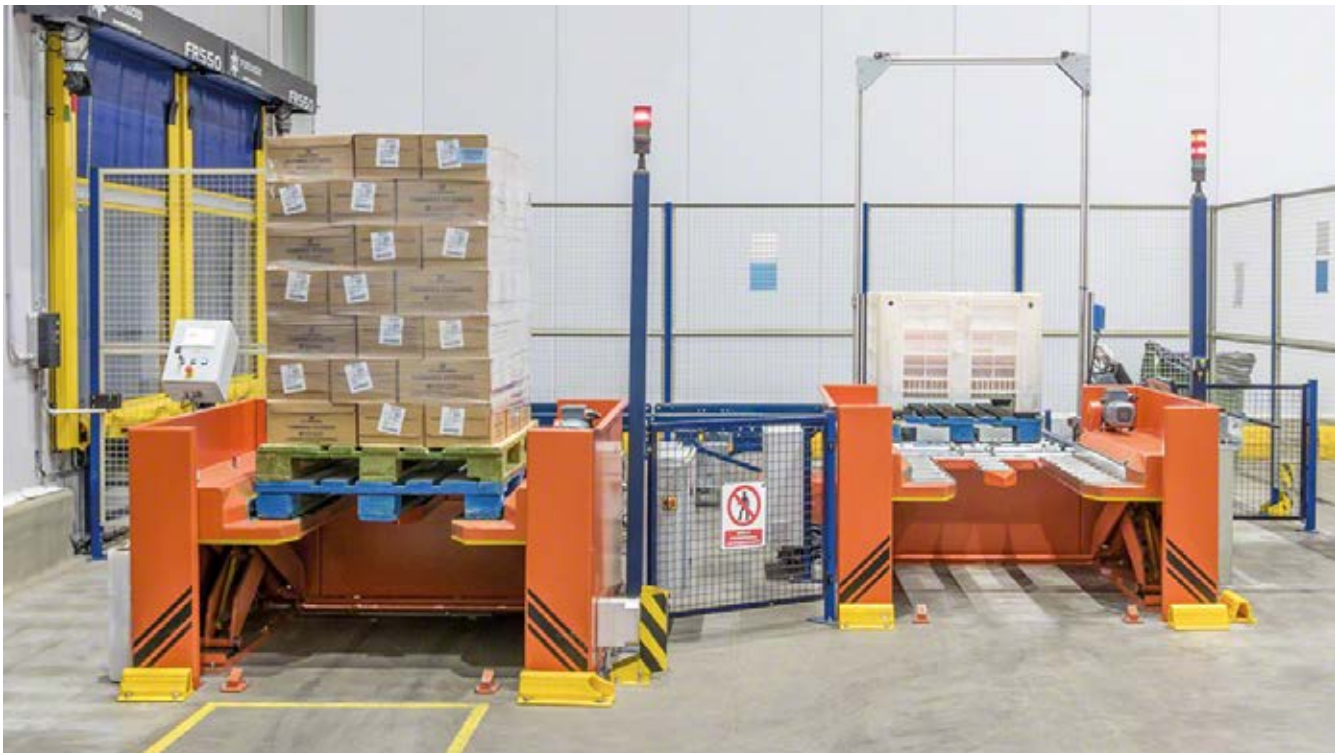



## Transfer car



A non-continuous unit load conveyor system. It comprises a shuttle that moves along guide rails in a straight line and joins several points in between. Its length is adapted to bridge the gap, since it is mounted on embedded or floor level stand-alone guide rails.

At least two additional roller or chain conveyors are needed, placed in a perpendicular direction to the workflows, such as loading and unloading stations.

Either for single or double loads (with a capacity to move one or two pallets), its top facet can include both forks, as well as roller or chain conveyors. Installations that require average workflows will find this an ideal solution.

In the case of a transfer car with a mounted roller conveyor, it can be hinged to adapt to the live channels' incline.



### TECHNICAL DATA

**Loaded transport speed:** up to 100 m/min

**Unloaded transport speed:** up to 140 m/min

**Max. load:** 1,500 kg (1 load) / 3,000 kg (2 loads)

**Loaded transfer acceleration:** up to 0.5 m/s<sup>2</sup>

**Unloaded transfer acceleration:** up to 1.0 m/s<sup>2</sup>

**Pallet types:** Euro pallets of 800 / 1,000 / 1,200 x 1,200 mm and half pallets

**Conveyor speed:** variable, up to 20 m/min

**Positioning system:** rangefinder

**Communication system:** infrared photocells

**Temperature range:** -30°C to +40°C and up to 70% humidity



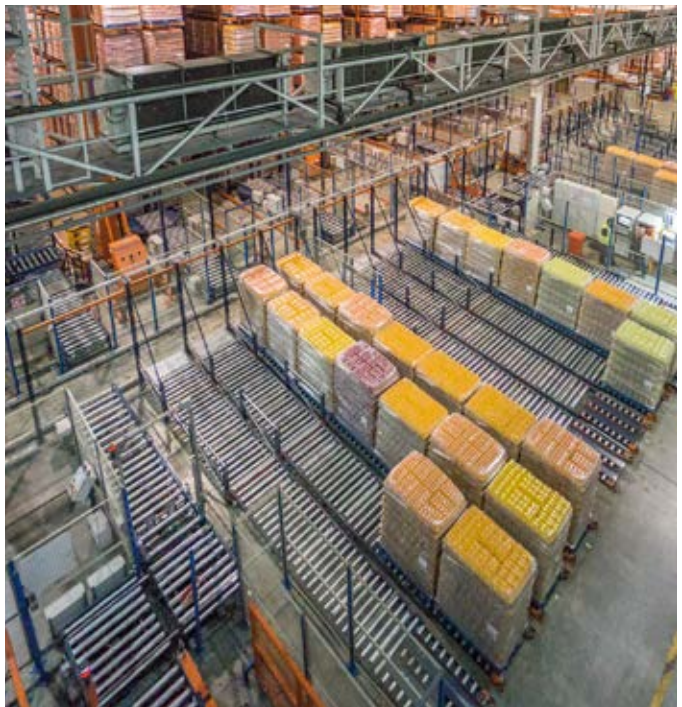



## Pallet lifts



An automated transport system to move palletised loads of up to 1,500 kg vertically. They provide fast fluid pallet flows between different floors or levels in an installation, by hoisting and lowering the goods.

Thanks to a counterbalance traction system, loads ascend and descend to the desired level.

The conveyor with a built-in lift must have the same type module as the lift's entry/exit unit. When the lift only carries out a single function (inputs or outputs), just one conveyor is needed per level. When input and output functions are combined, this must be supplemented by two conveyors per level.

Another option is to set up telescopic forks for specific applications.

### TECHNICAL DATA

**Pallet widths:** 800 / 1,000 / 1,200 mm and half pallets

**Max. unit load weight:** 1,500 kg

**Min./max. column length:** 4,150 / 35,000 mm

**Min. circuit:** 1,990 mm

**Lifting speed:** 80 m/min (up to 1,000 kg) /  
60 m/min (up to 1,500 kg)

**Lift acceleration:** 0.7 m/s<sup>2</sup> (up to 1,000 kg) /  
0.5 m/s<sup>2</sup> (up to 1,500 kg)

**Transfer acceleration:** 0.3 m/s<sup>2</sup>

**Lower transport level:**

500 / 600 / 900 / 1,100 mm (rollers)

550 / 650 / 950 / 1,150 mm (chains)

**Temperature range:** -30°C to +40°C  
and a max. 70% humidity

**Positioning:** rangefinder + encoder / resolver



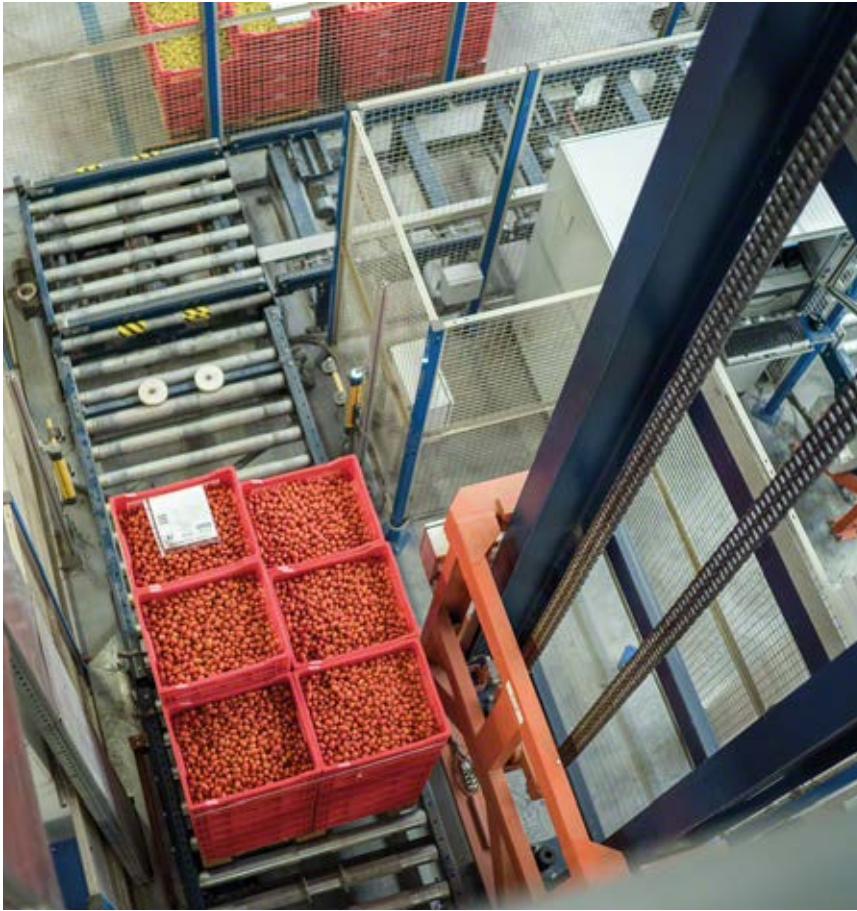

### Highlighted advantages

- Capacity to move up to 40 m high loads.
- Clad-rack steel structure for a safe, easy installation.
- Continuous pallet flows between areas.
- Vital in warehouse installations that need vertical gaps bridged, or various levels or floors, or even buildings connected.
- Productivity enhanced by cutting runtimes.





## Pallet transfer carts



Installed on guide rails, these move short distances to link various loading and unloading points. A conveyor (rollers or chains) with a single pallet capacity is fitted on top.

Running at a maximum speed of 60 m/min, it is highly-suited to installations that do not require high pallet/hour flows, offering a more affordable solution than a continuous conveyor circuit or a transfer car. Use them to organise and sort pallets in accumulation and standby areas.

As a minimum, the transfer cart requires a start point for inputs and another for delivery outputs. In other words, a minimum of two roller or chain conveyors is needed, placed in perpendicular to the moving cart.

### Highlighted advantages

- Links different locations that are a maximum of 12 m apart. Compared to a transfer car, it costs less.
- An ideal alternative to a standard recirculation system that uses more costly conveyors.

### TECHNICAL DATA

#### Load size:

900 x 1,300 / 1,100 x 1,300 mm / 1,300 x 1,300 mm

#### Max. unit load weight: 1,500 kg

Circuit: from 400 to 10,550 mm

Number of wheels: 4

Rail type: IPE 100

#### Standard transport height:

600 / 900 / 1,100 mm (rollers)

650 / 950 / 1,150 mm (chains)

Travel speed: 60 m/min

Travel acceleration: 0.8 m/s<sup>2</sup>

Conveyor speed: variable, up to 20 m/min

Positioning system: absolute encoder

Temperature range: between 0°C and +40°C and a max. 70% humidity





## Full pallet stacker



Equipment added to conveyor systems to stack loaded pallets, or half pallets, one on top of the other.

### Pallet stacker (1)

These stackers raise loaded pallets and deposit them on top of slave pallets, if the pallet's quality or size is unsuitable.

### Full pallet stacker (2)

This equipment lifts loaded pallets of different heights onto other loaded pallets to make use of all available space.

### TECHNICAL DATA (1)

**Required unit:** Euro pallet, as per UNE-EN 13698:2003

**Load size:** 900 x 1,300 / 1,100 x 1,300 mm / 1,300 x 1,300 mm

**Transport height:**  
600 / 900 / 1,110 mm (rollers)  
650 / 950 / 1,150 mm (chains)

**Vertical range:** 200 / 205 mm

**Max. unit load weight:** 1,000 / 1,500 kg

**Temperature range:** -30°C to +40°C  
and a max. 70 % humidity

### TECHNICAL DATA (2)

**Required unit:** Euro pallet, as per UNE-EN 13698:2003

**Load size:** 900 x 1,300 / 1,100 x 1,300 mm / 1,300 x 1,300 mm

**Transport height:**  
600 / 900 / 1,110 mm (rollers)  
650 / 950 / 1,150 mm (chains)

**Vertical range:** 1,255 / 1,755 mm

**Max. unit load weight:** 750 kg

**Temperature range:** -30°C to +40°C  
and a max. 70 % humidity

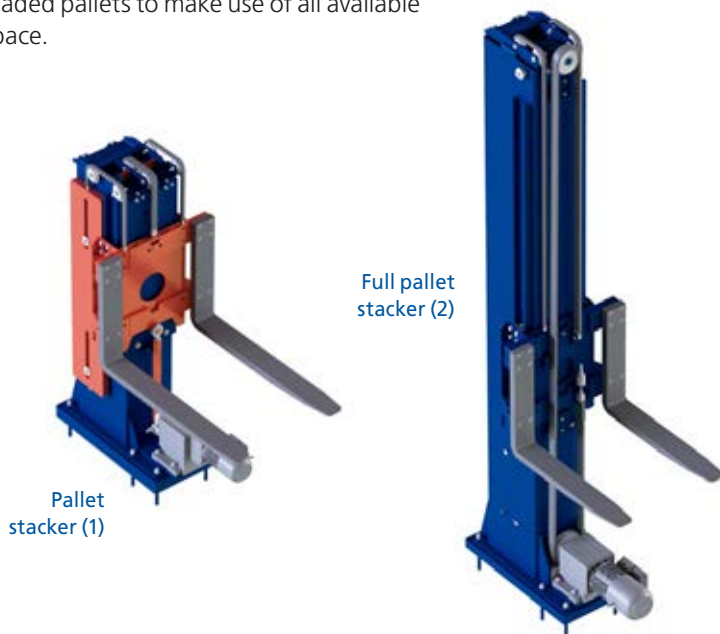



## Pallet stacker/unstacker



Equipment added to automated conveyor systems to easily store empty pallets or to insert them into a circuit.

This machine stacks and unstacks empty pallets one at a time. It creates piles of pallets to supply different picking stations or full pallet stackers with empty pallets as needed and can also feed production lines.

The roller or chain stacker places the pile of empty pallets on top of a new pallet using a system of electromechanical lifting hooks or rotating claws. To unstack these pallets, the pile is set on the conveyor and the pallets raised off the bottom pallet to free it for use.



### TECHNICAL DATA

**Required unit:** Euro pallet, as per UNE-EN 13689: 2003

**Pallet size:** 800 / 1,000 / 1,200 x 1,200 mm

**Available length in rollers/chains:** 1,340 / 1,302 mm

**Pallet guides:** guided wheels

**Standard roller transport height:** 600 / 900 / 1,100 mm

**Standard chain transport height:** 650 / 950 / 1,150 mm

**Transport height range:** 550 to 1,100 mm (rollers) –  
600 to 1,150 mm (chains)

**Roller diameter:** 60 mm / 80 mm

**Speed:** 10 / 20 m/min

**Max. stacking capacity:** 15 units

**Max. stacked load:** 350 kg

**Average stack/unstack cycle:** 12 s

**Average cycles/hour:** 200

**Temperature range:** -30°C to +40°C  
and a max. 70 % humidity



## Hinged connectors for chain conveyors



When a door needs installing in the middle of a chain conveyor circuit, whether fire-doors or ones to access cold-storage areas, transport lines are interrupted and a space of 200 or 300 mm must be left between the conveyors.

This hinged section, designed to fix this problem, bridges the gap between the chain conveyors when they are interspersed with a door, providing continuity to product flows when the door opens to let a pallet pass through.





## Electric monorail systems



Electric monorails are discontinuous transport systems consisting of automated or self-propelled trolleys, which move along a closed electrified rail circuit. A variable number of trolleys move around the circuit transferring pallets between different stations or staging points, following the orders received from the control and management programmes in charge of them.

The system's responsiveness in sending pallets to picking stations, preload areas, accumulation zones, etc. transforms electric monorails into the most high-powered system for transporting pallets, the ideal solution for a high percentage of installations.

Electrified monorails substitute or combine with roller or chain conveyors when medium or long circuits need to be set up, or when quick transport is necessary between different loading and unloading stations.

On the other hand, roller and chain conveyors, in their different variants, are the connecting elements that comprise the loading and unloading stations and link the circuit to the warehouse or the different operational areas.



In a circuit, the maximum number of pallets in motion is limited by how many trolleys are in operation. Conveyors must be installed in specific areas to create accumulation zones.

### Key advantages of electric monorail systems

- **Intelligent, autonomous transport.** Each trolley is assigned an origin and a destination point dynamically. Adjacent trolleys are permanently synchronised, which maintains a safe distance between each of them.





- **Top transport speeds.** The trolleys released into a circuit are in continuous motion and move at speeds of 100 m/minute when loaded and 120 m/minute when empty (roller or chain conveyors usually do not exceed 20 m/minute). Stop times at a station are minimal, whether to collect or deposit loads.
- **Flexibility.** The number of trolleys moving simultaneously inside a circuit can be modified, adapting to how many pallets must be moved. It is also feasible to set up lines to park the trolleys.
- **Smooth, silent movements.** It moves smoothly and quietly, due to superior acceleration and brake technology in curved sections. The trolley's light design, its wheels, as well as the features of the engine and the transmission components also play a part.
- **Low power consumption.** Thanks to its design and the type of engine used.
- **Reliability.** The system keeps operating when a trolley is extracted from the circuit because of an incident or if it needs maintenance.
- **Connections are modified quickly.** The initial circuit can be extended to include new junctions (loading or unloading points) at any time or relocated, if required.
- **Increased productivity.** Trolleys can be easily added to a circuit to deal with increases in production.
- **Low maintenance.** Maintenance is done outside the circuit, in an integrated area through a diverter, without blocking the rest of the trolleys in operation.
- **Greater cleanability.** Both the aerial electric monorails, due to the ground being obstacle-free, and the electrified monorail anchored to the floor use a single guide rail.
- **Configurable trolley circuits.** Circuits contain straight and curved sections. Diverters can be included to adapt the circuit to diverse operations, incorporating midpoint changes and parallel lanes, or creating parking zones or maintenance areas.
- **Rollers or chains.** Trolleys can transfer loads by means of rollers or chains, depending on the direction the pallets are transported.





### Constructive systems

Trolleys can move along I-shaped rails suspended from the warehouse's ceiling or attached to the floor. The operational benefits of both electrified monorail systems are similar. Choosing one or the other will depend on how the system will be used and an installation's features.

### Aerial electrified monorails

Trolleys slide along guide rails hung from the ceiling or an elevated structure.



Aerial electrified monorails are the best choice in the following situations:

- When pallet flows need to be raised off the floor, to not interfere with other operations.
- In cases where the floor is of substandard quality or is uneven.
- Whenever there are small areas to level out, with up to a 3% incline.
- When middle passageways need to be created for personnel and/or handling equipment.
- When a zone needs constant cleaning, which may happen in the food sector or when a company works in low or high temperatures.





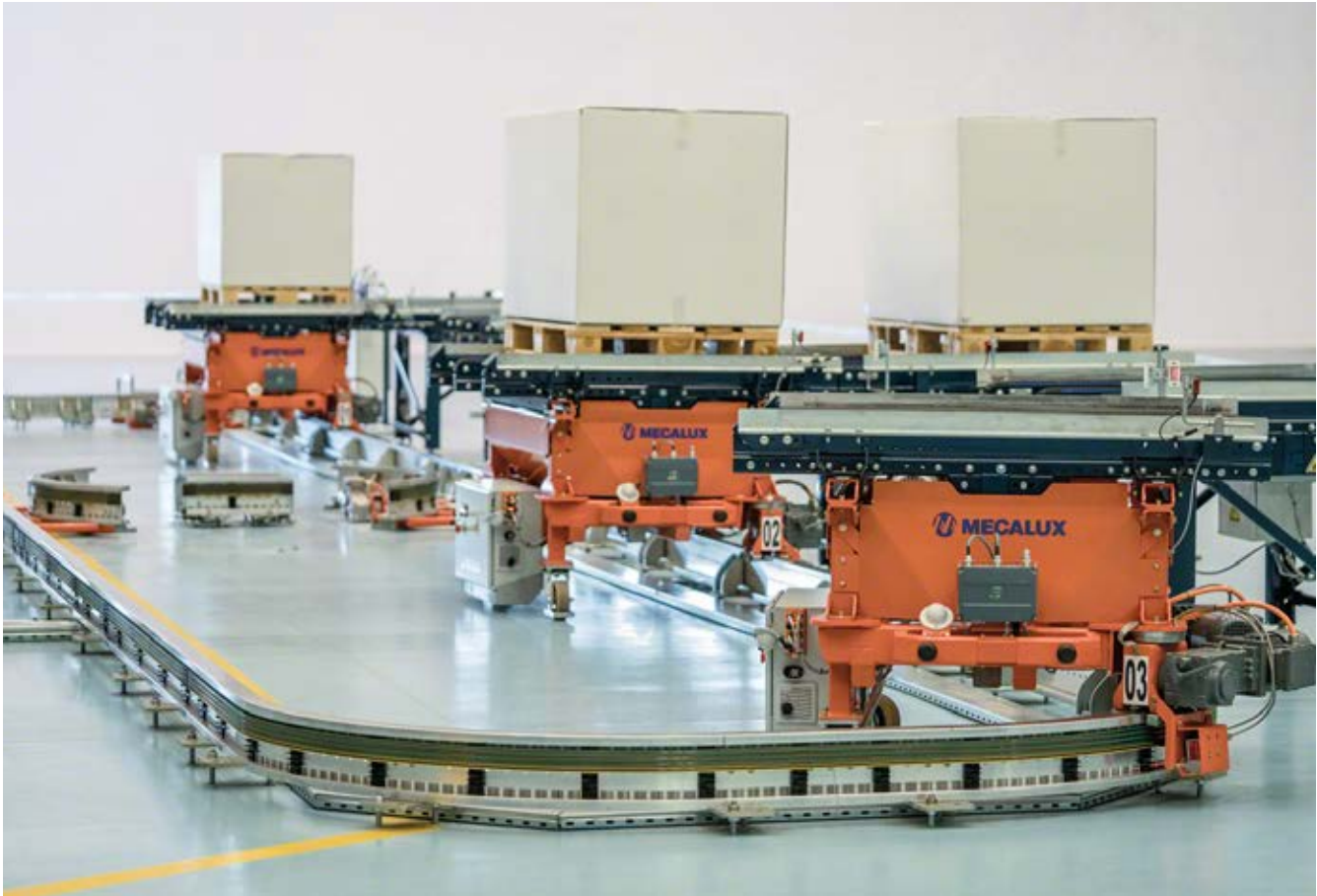

### Inverted electric monorails

The guide rails are attached directly to the floor.

These ground level or 'inverted' electric monorails are best suited to medium-sized circuits. Setting them up is very simple, since the system only requires a robust, level floor surface to fix the guide rails.

Tight turning radiuses are possible, letting circuits be easily modified, since they do not include any additional structures.



### TECHNICAL DATA FOR BOTH SYSTEMS

**Max. load:** up to 1,500 kg

**Pallet types:** (2) 800 x 600 mm – 800 x 1,200 mm  
1,000 x 1,200 mm – 1,200 x 1,200 mm

**Loaded speed:** up to 100 m/min

**Unloaded speed:** up to 120 m/min

**Transfer acceleration:** up to 0.7 m/s<sup>2</sup>

**Engine:** Lenze / SEW

**Temperature range:** -30 °C to +40 °C

**Onboard conveyor:** rollers / chains

**Positioning:** BPS (Barcode Positioning System)

**Communication system:** Wi-Fi



# Stainless steel equipment

The best anti-corrosion finish on the market

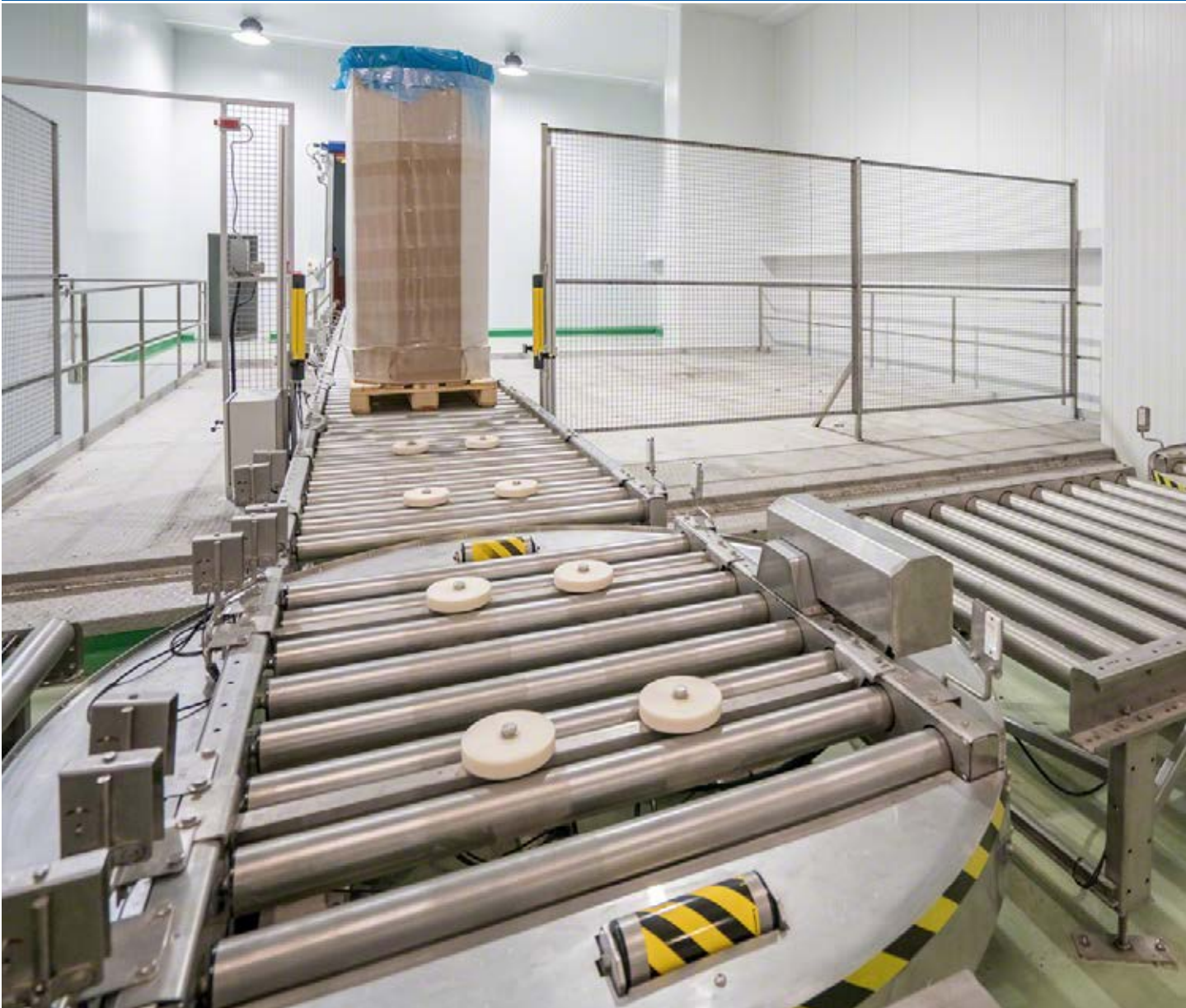

We also make conveyors out of stainless steel, a material with excellent rust resistance properties to provide more uses for the different pallet conveyors.

This material is especially suitable for wet zones. For example, in food production areas, harsh environments, or those that require cleaning with water or disinfectants.

In this way, stainless steel conveying equipment fulfils the needs of the many industrial production and packaging areas, especially to do with foods.

All electrical and electronic parts incorporated into the conveyors –such as sensors or motors– are protected by an IP protection rating suited to these types of facilities.







# Safety measures

Accessories to properly protect operators and your installation

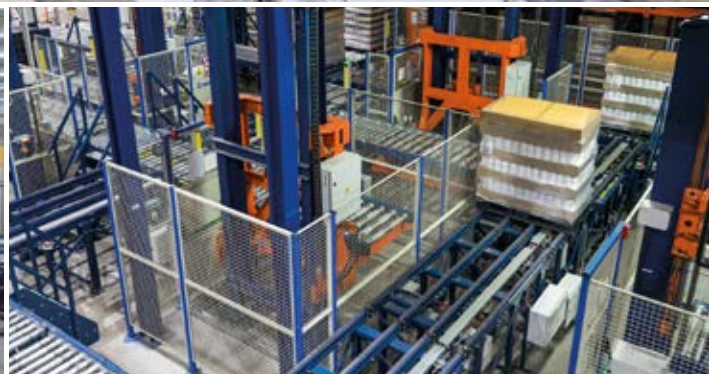



## Pallet checkpoints



A checkpoint and input control are installed in cases where pallet dimensions, weights and conditions must be verified to fulfil installation specifications, especially when the transport system is used to insert pallets into an automated warehouse.

It can be fitted with a barcode reader to identify and then register product in the warehouse management system. Two devices can also be installed to control the condition and quality of the transport base, to guarantee proper pallet transport and storage. One device controls the spaces where forks are inserted and the other the support beams in the racks.

In the event an irregularity is detected, the unit load is rejected and the operations panel displays the defect that needs reconditioning.



### TECHNICAL DATA

**Required unit:** Euro pallet, as per UNE-EN 13689: 2003

**Load size:** 900 x 1,300 / 1,100 x 1,300 / 1,300 x 1,300 mm

**Pallet guide:** guide wheels

**Transport length:** 1,673 / 1,840 / 2,004 mm

**Standard transport height:** 600 / 900 / 1,100 mm

**Max. load:** 1,500 kg

**Roller diameter:** 80 mm

**Speed:** 20 m/min

**Stop photocells:** 2

**Temperature range:** -30°C to +40°C and a max. 70 % humidity



## Wire mesh partitions and cages



These consist of vertical mesh panels and doors with access-control devices. Their main function is to mark out dangerous areas in the conveyor circuit to prevent accidents.

Once an installation's conveyors are fully arranged, a risk assessment must be done to determine the points that must be protected. As a general rule, they are:

- **Side and frontal access points to transfer cars** or transfer carts.
- **Side and frontal access points to pallet lifts** on all floors.
- **Stacker crane aisle access points.**
- **Mixed conveyors** because of the risk of entrapment.
- **Conveyors of less than 1,000 mm in height**, which coincide with automated machinery.
- **Any zone where there is a risk** of entrapment, crushing, falls, etc. Chain conveyors are considered an entrapment risk, whereas those with rollers are not. Accessories can also be installed on them such as **electronic safety barriers** to block passage through open areas.

## Conveyor fenders



These metallic fenders prevent damage to incoming and outgoing conveyors when a forklift is placing or removing pallets. Entry fenders have pallet centralisers that make sure the unit load is placed properly on the conveyor.

These fenders are fastened to the floor, with a space between them and the conveyor. So, if they are hit by a forklift, the system's overall operation is not affected.





## Horizontal wire safety mesh



For conveyors that face aisles with moving machinery, horizontal wire mesh partitions can be installed to cover openings and prevent access.

Warning and prohibition signalling are also added. The risk analysis carried out in each installation will determine what must be signalled.

## Pedestrian walkways



Fixed elements that let operators cross the circuit and access the other side safely and easily, preventing any danger of falls or entrapment.

When access stairways are added, pedestrian walkways are also often used for maintenance tasks.



## Roller doors

They constitute another risk prevention and safety solution for personnel, which is mainly set up in areas with pallet lifts.



# Manage and control your system

The brains behind automated conveyor circuits for heavy loads

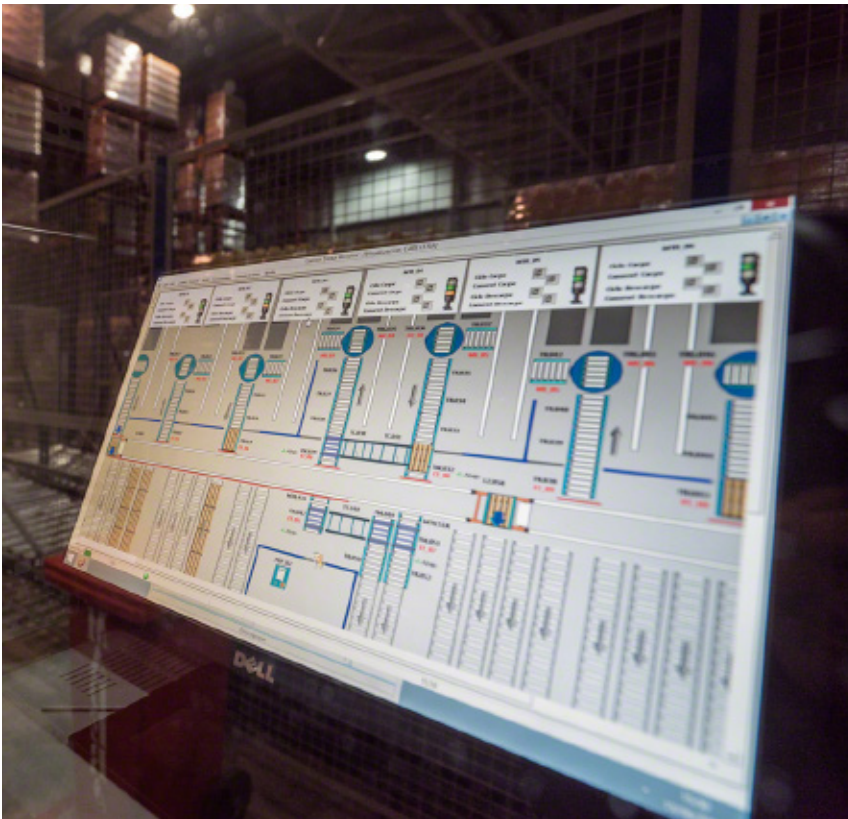

Our software solutions are easy to implement, and are developed and updated continually by the Mecalux Software Solutions division, made up of a team of 200 exclusively dedicated engineers.

These solutions for logistics facilities ensure optimal performance from day one and comprise two key programmes:

- **Control software:** in charge of running the machinery.
- **Management software:** in charge of the installation's operations.



## Control system

The programme that runs the control system follows previously parameterised, logical sequences, which take into account the route, the number of conveyors, the types of conveyor modules, the photocells and all other components within the circuit.

The control system sends pallets onwards, stops or turns them, etc. To do so, photocells are placed on the conveyors identifying where the pallet is located and informing the control system of this location –so the system can transmit the next movement. This programme should not be confused with the Warehouse Management Software (WMS), which acts as an upper managing layer and runs the control software. Usually, a conveyor system does not require a warehouse management program, except when it is connected to a complex installation, as happens with the main conveyor systems used in automated warehouses.

Conveyor circuits, except those using the plug & play system, require a control system that transmits orders to them. Whether the control system is simple or complex will depend on the circuit's size and route.

There are four different types:

**Plug & play:** each conveyor includes a microcontroller that manages its movements automatically. This involves a decentralised control device, since the conveyors do not share information. Neither does it include viewing devices, nor a management system that directs pallet flows. External add-on devices can be included, such as lifts, stretch wrap machines, transfer cars, etc.,



as long as they have their own control programme or a basic PLC. In this case, conveyors only send or receive occupancy or stop signals. This is recommended for small and non-complex installations.

**Basic PLC:** made out of standard, commercially available components from different manufacturers, and specifically for centralised control functions. In this case, as there is a fieldbus. Complex equipment like scanners, scales, sensors can be connected or even communication with a warehouse management software. It is suited to small installations, which are more complex than those controlled by a plug & play system.

**PC:** our Galileo control system. This is a centralised control system that gathers all the information from an installation. It establishes communication with the warehouse's management system and is also responsible for the physical movements of the equipment and displaying workflows on the PC's screen. Recommended for all types of installations.

**PLC:** made of standard, commercially available components from different manufacturers, it can carry out the same functions as a PC control system, although an additional PC is needed as a viewing screen.





## Warehouse management system

### Management system

This management system provides overall management of all warehouse software, and should not be confused with the control system. Usually, a conveyor does not require a management system to operate properly, except when it is connected to a complex installation with multiple commands or destination points, like the main conveyor systems in automated warehouses.

This information management software was designed to sort out the physical and document management of product flows from their input into the warehouse to their eventual dispatch.

This whole process is based on continuous planning, which provides overall monitoring of activities and real-time stock control.

Applied to a warehouse, the management system lets you control not only all pallet movements, but also stock levels once they are put into their storage location, the status of stock transported on a given date, possible loading gauge errors, the location and optimisation of each and every product, etc. In other words, it executes comprehensive management of all warehouse fulfilment processes.





**Easy WMS, our warehouse management system**, is built into predetermined levels that allow the software to be personalised, and even individualised adjustments to be done. Moreover, Easy WMS uses standard communication interfaces from the main ERPs on the market, developed to achieve maximum security and stability. Easy WMS is a powerful, robust, versatile and flexible software that efficiently

controls, coordinates and manages all movements and operational processes in a warehouse. For example, the reception of goods, storage tasks, real-time inventory, order picking and dispatching.

Its implementation gives you major advantages, such as:

1. **Increased logistical productivity** and fewer operations.

2. **Speedier preparation** and dispatch of orders.
3. **Errors** made with incoming and outgoing material are **reduced by up to 99%**.
4. **Control and optimisation** of stock.
5. **Real-time inventory** and tracking of goods.
6. **Reduced logistics costs** by optimising workforce resources and handling costs.
7. **Capacity to adapt** to changing business needs or market trends, such as e-commerce.
8. **Improved document management.**

For more information, request the Easy WMS catalogue or contact our sales department and ask for a demo or some obligation-free advice.

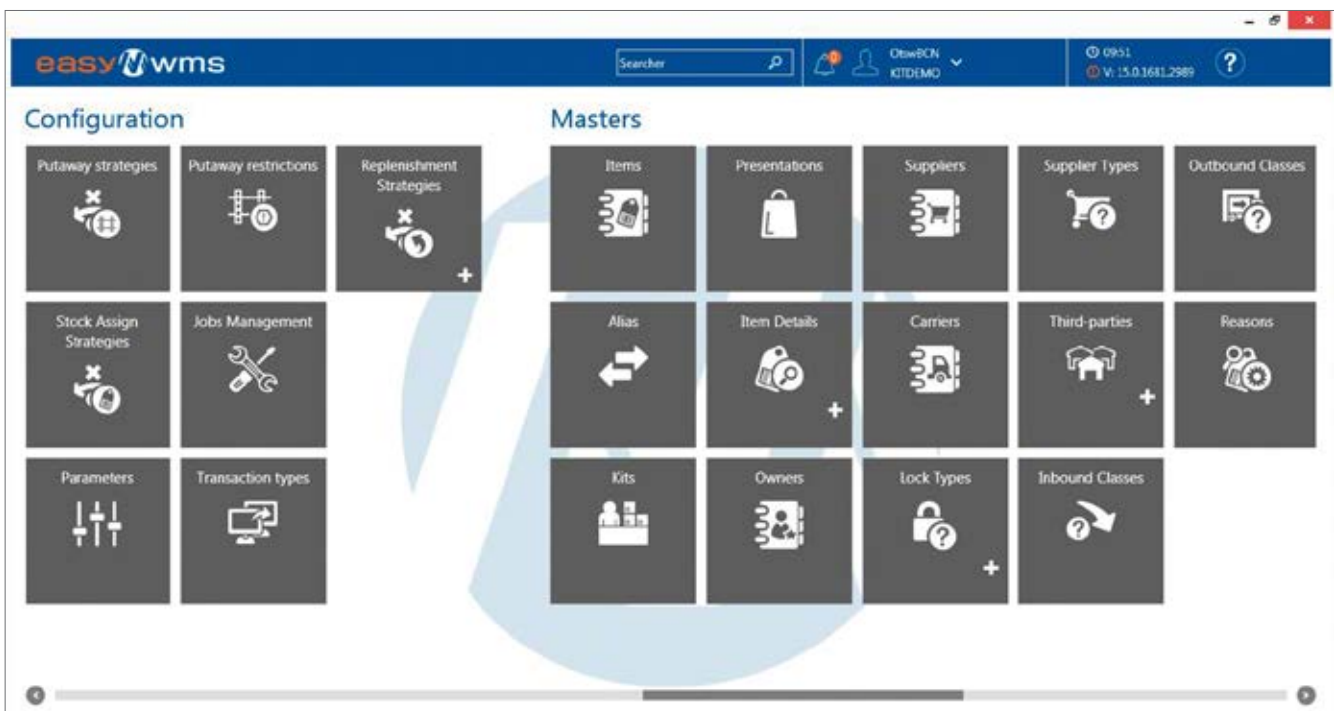



# Applications

Custom designs mean higher profits, as well as more speed and innovation in all kinds of warehouses and production centres



Installing automated pallet conveyor system is worthwhile for any business sector or product type where logistics operations need streamlining. Conveyor systems make business sense when you need to:

- **Eliminate frequent, repetitive, manual handling** of unit loads between specific locations in an installation.
- **Streamline movements** that flow along a fixed route.
- **Achieve faster**, high-volume transport of products or manage high workflows.
- **Prevent saturation** at the ends of production lines.

- **Create an orderly accumulation system.** Accumulation of pallets is possible, creating a buffer zone for shipments or regulating workflows.
- **Prevent bottlenecks** due to variable peaks in activity or inefficient management of warehouse flows.
- **Increase safety** during risky manual operations or when goods need to be better protected.
- **Improve efficiency** when loading and unloading transport vehicles.





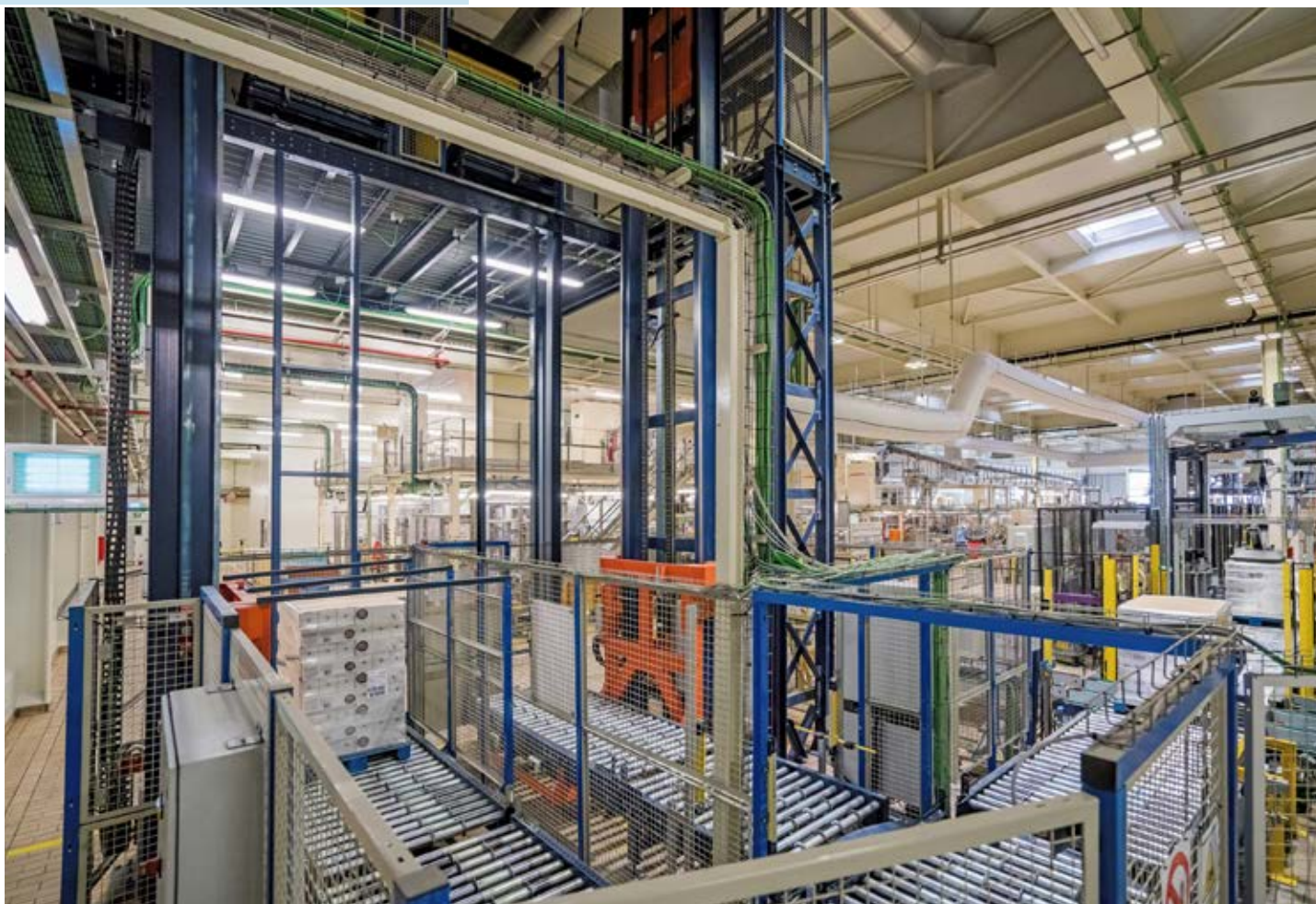

### Simulation software

Mecalux has developed a specific software to carry out realistic simulations of warehouse operations and to visualise very high workflows. The software lets you establish diverse layouts, analyse product turnover, etc., before actually installing a conveyor system. That way, customers can ensure the final configuration fulfils the design parameters.

Simulations are used especially in complex installations, like automated circuits with multiple entry and exit points and elevated workflows.

This program provides numerous tools to design, simulate, present and implement projects.

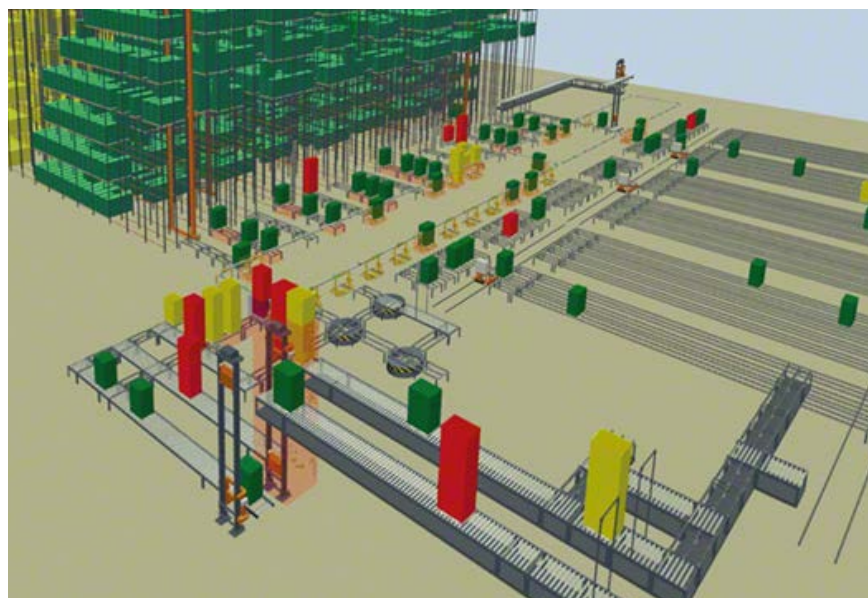

In addition, it includes a 3D simulator that shows the different variations according to the warehouse's

product types, what sort of orders are prepared, etc.



# After-sales services

Customised after-sales maintenance and support for your warehouse

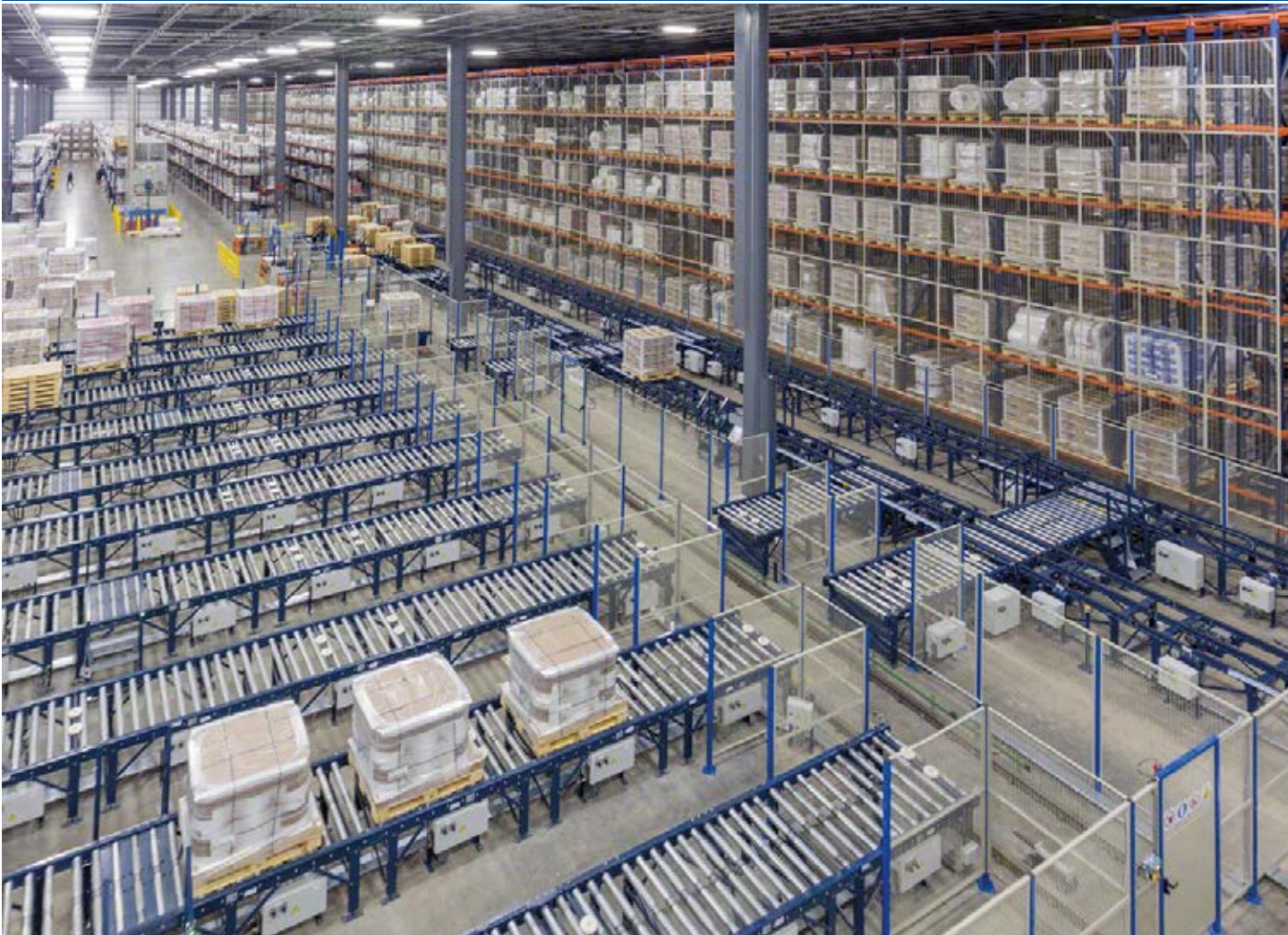

After a storage installation is up and running, especially those that include automated systems, it is crucial to have a detailed maintenance plan that ensures optimal, uninterrupted operations in your warehouse.

Given how important maintenance is, it is an investment rather than a cost of doing business. It extends the life of your handling and conveying equipment, and gives your company a competitive edge.

We offer our customers from around the world diverse after-sales services

to guarantee top production levels in installations and to prolong the lifespan of their equipment. Our after-sales service team is trained by Mecalux professionals who have extensive experience and a deep, comprehensive knowledge of our products.

Since each installation is unique, Mecalux studies each case very carefully to present a maintenance and support plan suited to the specific needs of each customer.





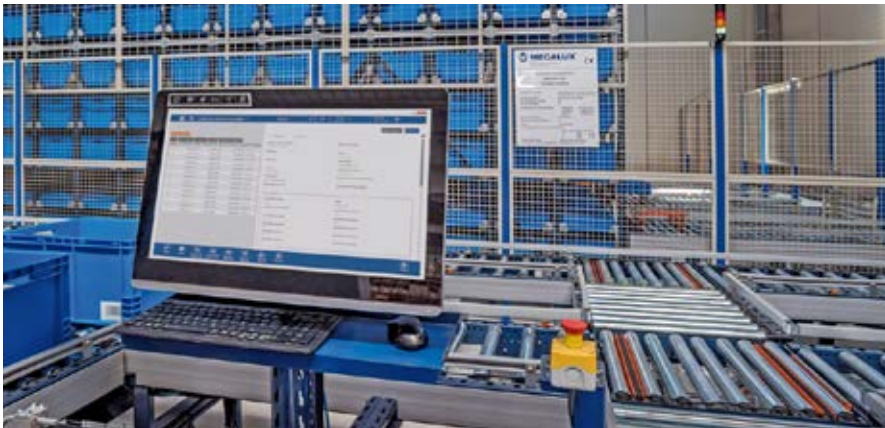

## All out after-sales services



### AUTOMATED SYSTEMS

**PREVENTIVE MAINTENANCE:** services that anticipate and identify possible breakdowns in your automated handling equipment.

**ELECTROMECHANICAL SERVICES:** personalised 24-hour telephone, remote maintenance or on-site customer service.

**PRODUCTION ASSISTANCE SERVICES:** an in-house technician for warehouses that require special attention.



### WAREHOUSE MANAGEMENT SOFTWARE

**TELEMAINTENANCE SERVICES:** remote maintenance for installations using our Easy WMS warehouse management system. It includes the Easy Monitor online tracking system.



### CONSULTING AND TRAINING SERVICES

**CONSULTING SERVICES:** expert support from our technical department if you are thinking of expanding, modifying, modernising or moving storage equipment.

**TRAINING SERVICES:** courses about optimal equipment operations or other safety-related issues.



### METAL PALLET RACKS

**RACK MAINTENANCE SERVICES:** general upkeep and supervision to guarantee rack safety.

**TECHNICAL RACK INSPECTION SERVICE:** inspections by qualified technicians so your installations complies with the UNE-EN 15635 standard.





**HEAD OFFICE - SPAIN** - Silici, 1 - 08940 Cornellà de Llobregat - Barcelona  
**Tel. +34 932 616 913 – info@mecalux.com – mecalux.com**

**EUROPE**

**BELGIUM**

Tel. +32 2 346 90 71  
info@mecalux.be  
**mecalux.be**

**CZECHIA**

Tel. +420 222 524 240  
info@mecalux.cz  
**mecalux.cz**

**FRANCE**

Tel. +33 01 60 11 92 92  
info@mecalux.fr  
**mecalux.fr**

**GERMANY**

Tel. +49 (0) 2133 5065 0  
info@mecalux.de  
**mecalux.de**

**ITALY**

Tel. +39 02 98836601  
info@mecalux.it  
**mecalux.it**

**NETHERLANDS**

Tel. +31 208 08 30 96  
info@mecalux.nl  
**mecalux.nl**

**POLAND**

Tel. +48 32-331 69 66  
info@mecalux.pl  
**mecalux.pl**

**PORTUGAL**

Tel. +351 21 415 18 90  
info@mecalux.pt  
**mecalux.pt**

**SLOVAKIA**

Tel. +421 220 545 117  
info@mecalux.sk  
**mecalux.sk**

**TURKEY**

Tel. +90 216 706 10 15  
info@mecalux.com.tr  
**mecalux.com.tr**

**UNITED KINGDOM**

Tel. +44 0121 3336 602  
info@mecalux.co.uk  
**mecalux.co.uk**

**AMERICA**

**ARGENTINA**  
Tel. +54 (11) 4006-4444  
info@mecalux.com.ar  
**mecalux.com.ar**

**BRAZIL**

Tel. +55 19 3809-6800  
info@mecalux.com.br  
**mecalux.com.br**

**CHILE**

Tel. +56 (2) 2827 6000  
info@mecalux.cl  
**mecalux.cl**

**COLOMBIA**

Tel. +57 01 8000 423 553  
info@mecalux.com.co  
**mecalux.com.co**

**MEXICO**

Tel. +52 800 030 0185  
info@mecalux.com.mx  
**mecalux.com.mx**

**URUGUAY**

Tel. +598 2683-8879  
info@mecalux.com.uy  
**mecalux.com.uy**

**USA**

Tel. 1-877-632-2589  
info@interlakemecalux.com  
**interlakemecalux.com**

